

Coolant Heater

General Operation Manual



WARNING: Cancer and Reproductive Harm
www.P65Warnings.ca.gov

NOTES

Introduction

Dear Webasto Customer,

Thank you for choosing a Webasto heater.

Webasto coolant heaters are used

- to provide engine pre-heat for boats, trucks, minibuses, vans, motor-homes, etc.
- to provide auxiliary heating for boats, trucks, minibuses, vans, motor-homes, etc.
- to provide area heating through the use of fan-assisted heat exchangers

We presume that the principle and mode of operation of your new heater has been explained to your complete satisfaction by the workshop or service center which installed the heater. In these operating instructions we would like to once again provide you with an overview of the safe use of your new heater.

Repair work should only be carried out by an authorized Webasto dealer.



Servicing and Safety Instructions

1. When the heater is in use, the surface of the heat exchanger will become hot to the touch. Contact with skin may cause burns.
2. **Webasto heaters must be switched "off" when re-fueling at gas stations and/or while loading or unloading flammable materials for transport, to prevent the risk of explosion.**
3. The year in which the heater was used for the first time must be permanently displayed on the factory plate by deleting the inapplicable years from the plate.
4. **The heaters are not designed for heating hazardous substance transport compartments.**
5. Claims can only be made if it can be verified that the claimant has complied with the servicing and safety instructions.
6. **The heater may not be operated in enclosed spaces (such as garages) as a result of the risk of poisoning and asphyxiation, even if a timer is used.**
7. In the event of long-lasting heavy smoke development, unusual combustion noises or a smell of fuel or if the heater suffers continuous fault cut-outs with error messages (on select models), it must be shut down by removing the fuse and must not be used until it has been inspected by Webasto-trained personnel.
8. **Wherever flammable vapors or dust may form, the heater must be switched off as a result of the risk of explosion.**
9. The heat transfer unit on coolant heaters is exposed to very high thermal stress and must be replaced by a genuine Webasto spare part after a ten year life cycle.
10. **The fuel specified by the vehicle manufacturer is suitable for use in Webasto heaters.**
There are no known negative influences due to fuel additives when used appropriately.
If fuel is extracted from the vehicle's tank, follow the additive instructions issued by the vehicle manufacturer.
If you change to low-temperature fuel, the heater must be operated for approx. 15 minutes so that the fuel system is filled with the new fuel.
11. The temperature in the area around the heater must not exceed 85 °C / 185° F (storage temperature). If the temperature exceeds this level there is a risk of permanent damage to the electronics systems.
12. **Non-compliance with the installation instructions and the warnings contained therein will lead to the exclusion of all liability by Webasto. The same applies if repairs are carried out incorrectly or by untrained technicians or with the use of parts other than genuine spare parts. This will result in the invalidation of the type approval for the heater unit.**
13. To prevent mechanical parts seizing, the heater should be operated for approx. 20 minutes once a month.
14. **Do not stand on the heater, do not place any items of clothing, textiles or similar materials over the heater or the pipes/hoses carrying heated coolant.**
15. The heater must not be cleaned with a high pressure cleaner.

Control Element

Using the Switch

Switching ON:

When the switch is used, the operation indicator (toggle) lights up. Shortly thereafter, the heater begins operation and delivers heated coolant to the engine or heat exchanger.

Switching OFF:

When heating is no longer required, switch the toggle switch OFF. The indicator light turns off, combustion extinguishes, followed by an after-run cycle.

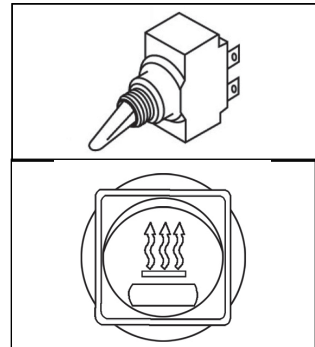

SmarTemp Control



* The micro USB service port is not used for heater diagnostic purposes on SmarTemp Control fc 2.0

Menu Description

Refer to Menu Descriptions Table for a detailed description of each menu item and its default setting. Depending on the SmarTemp version, menu order may vary from below.

	Definitions	Default
Mode	Two modes are possible: - Auto mode enables the pre-defined timer programs. Manual ON/OFF functionality is still possible while in this mode. - Manual Mode allows the heater to be operated via the Webasto button on the SmarTemp Control fx 2.0. While in Manual Mode, all Auto Mode functionality is permanently disabled. Note: While in manual mode the heater will continue to operate based on the pre-defined "Duration" set by the user. See "Duration" for further detail.	Manual
Language	Language changes between English, Spanish, and French.	English
Duration	Duration allows user to select the heater runtime of the heater. Set range is between 10 – 120 minutes selectable by 10 minute increments. Note: Duration time for all timers will default to the set duration time. User will have the ability to manually change duration for each timer.	60 minutes
Error Code	This section will log the last 5 error codes and the date that it was set. Highlight and select an error code for a full description. If the heater produces an error code, the status indicator lights will flash red and the error will display on the main screen. Error codes cannot be reset through the Webasto SmarTemp Control fx 2.0 on the heater, a Webasto PC Diagnostics tool is needed. Refer to the heater service manual for resetting an error code. Note: Diagnostics via blink code is not available on <u>all</u> coolant heaters. Error Codes on products with no blink code functionality can still be obtained using the PC Diagnostics test tool. Refer to the applicable service manual by visiting www.techwebasto.com for detailed PC diagnostics information.	No Errors
Options	Advanced level adjustments; see below	
<i>Time and Date</i>	Time & Date allows user to properly set the current date and time. User also has the ability to switch between AM/PM and 24 hour format. If the 24 hour format is selected the date format will change to dd/mm/yyyy. Use the rotary knob to choose the time / date and the selection button to confirm each entry. The Webasto button can be used to go back to the previous field if additional changes are needed.	AM/PM mm/dd/yyyy
<i>Timer</i>	There are 4 heater start-up cycles possible 7 days per week. The timer is separated into to three categories. The user can select "Mon-Fri", set each specific timer (T1 – T4) for a typical work week all at once. A weekend "Sat-Sun" can be scheduled in the same manner or a full week by using the "Mon-Sun" selection. The "custom" link allows the user to set a specific timer (T1 – T4) for each individual day. When selecting a specific timer a sub-menu will appear (Edit, Skip, and Off). To change the timer cycle, select "edit". Changes are saved immediately. The "skip" feature allows a timer cycle to be skipped one time within a 7 day period. Timer will reactivate after this one-time skip cycle. Note: To turn a specific timer off permanently select "off".	
<i>LVD</i>	LVD "Low Voltage Disconnect" allows the user to adjust the battery voltage level at which the Webasto SmarTemp Control fx 2.0 will shut the heater off. A warning (LED and message) will appear after 8 minutes of low voltage. The warning will remain on for 2 minutes before the heater is shut off. If battery voltage is equal to or less than the threshold selected +0.1v, the heater will not start. i.e. if an 11.5v threshold is selected the heater cannot be started until B+ has reached 11.7v. 12 volt - Range between 11v – 12.5v 24 volt - Range between 21v – 25.5v	11.4v 24.2v
<i>Default</i>	Default allows the user to perform a reset to all default values. Note: A power loss will not reset user programmed values.	N/A
<i>Password</i>	A password can be set to prevent access to the advanced "Options" menu. Enter a 4 digit pass-code to begin securing the "Options" menu. Note: This is typically used in fleet vehicle applications.	OFF
<i>Hour Meter</i>	The hour meter logs the operating hours of an active ON signal to the heater. This does not reflect the true runtime of the heater itself. Note: For warranty purposes a diagnostic printout is still required where applicable. This hour meter is for reference only	N/A
<i>SW Version</i>	This displays the firmware version of the Webasto SmarTemp Control fx 2.0.	Installed Version
<i>Back</i>	Select this to return to the previous screen	

IMPORTANT - The Red status indicators (heater "ON") and LCD screen backlight turn off after 30 seconds. A touch of any button or a turn of the rotary knob will re-activate these lights. If the "Webasto" button is used to re-activate these lights, an additional press of this button is necessary to turn the heater off. Note that when the heater is "ON"

Programming the 24 Hour Digital Timer with 3 Time Settings

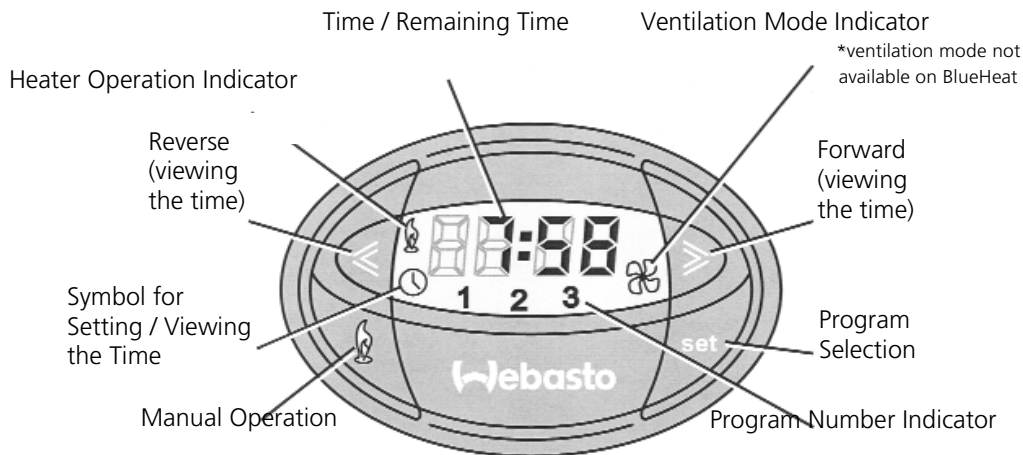

Operation.

Operation of the timer is designed so that the symbols flash rapidly in the setting mode. If no button is pressed within 5 seconds, the displayed time will be saved.

The display changes at high speed when the \Leftarrow and \Rightarrow buttons are pressed for more than 2 seconds.

Whenever the power supply to the timer is disconnected, all previously programmed settings will be lost.

Switching On.

Manually: by pressing the "Manual Operation"  button (continuous heating mode).

The heating time and the symbol for heating operation  are displayed.

The heating time display disappears after 10 seconds.

Automatically: upon reaching the preset starting time for heating.

The program number and the symbol for heating  are displayed.

Switching Off.

Manually: by pressing the "Manual Operation"  button.

Automatically: via the programmed end time.

The display field goes out when the heating time expires.

Setting the Time.

This function is not available when heating mode is active!

Press and hold the **set** button. Press the "Forward" \Rightarrow or "Reverse" \Leftarrow button as well.

The time of the day is displayed and the clock symbol  flashes.

Set the time via the "Forward" \Rightarrow or "Reverse" \Leftarrow buttons.

The set time is saved when the display goes out or by pressing the **set** button.

Viewing the Time.

Press the "Forward" \Rightarrow or "Reverse" \Leftarrow button.

NOTE:

The remaining operating time is displayed if heating mode is active.

Programming the 24 Hour Digital Timer with 3 Time Settings Continued:

Program Start of Heating.

Press the **set** button. Press the "Forward" \gg or "Reverse" \ll buttons within 10 seconds until the required time for starting heating operation is displayed.

If a different program number is required, the **set** button must be pressed within 10 seconds.

Default start settings:

Time 1: 06:00 hours or 6:00 am

Time 2: 16:00 hours or 4:00 pm

Time 3: 22:00 hours or 10:00 pm

NOTE:

The default settings are overwritten when new values are entered. The preset times are saved until changed. The default settings are restored when the timer is disconnected from the on-board power supply.

Deactivate Preset Time.

Briefly press the **set** button.

Select Preset Time.

Press the **set** button within 10 seconds until the program number with the required preset time is displayed. The active mode (heating \heating) and the program number flash.

Set Heating Duration Time.

Press and hold the **set** button. Press the "Forward" \gg or "Reverse" \ll button as well. Release both buttons. The time and clock symbol \clock are displayed.

Press and hold the **set** button again. Press the "Forward" \gg or "Reverse" \ll button as well. Release both buttons. The preset time is displayed and the heating symbol \heating and ventilation symbol \vent flash. Set the heating time via the "Forward" \gg or "Reverse" \ll buttons. The set heating time is saved when the display goes out or by pressing the **set** button.

NOTE:

The default settings are restored when the timer is disconnected from the on-board power supply. In this case, the timer will revert to the default heating duration time setting of 30 minutes.

Set Remaining Time.

The active remaining time can be changed between 10 minutes and 60 minutes via the "Forward" \gg or "Reverse" \ll buttons when heating mode is active.

*Changing the Operating Mode.

NOTE:

Ventilation mode is not available on the BlueHeat heater. The ventilation mode is only available with certain heater versions. This information is provided in the event mode of operation is inadvertently changed.

Press the **set** button. Press the **set** button again and hold it.

The last mode (heating \heating or ventilation \vent) is displayed. Press the "Forward" \gg or "Reverse" \ll button as well to change back and forth between heating \heating or ventilation \vent mode.

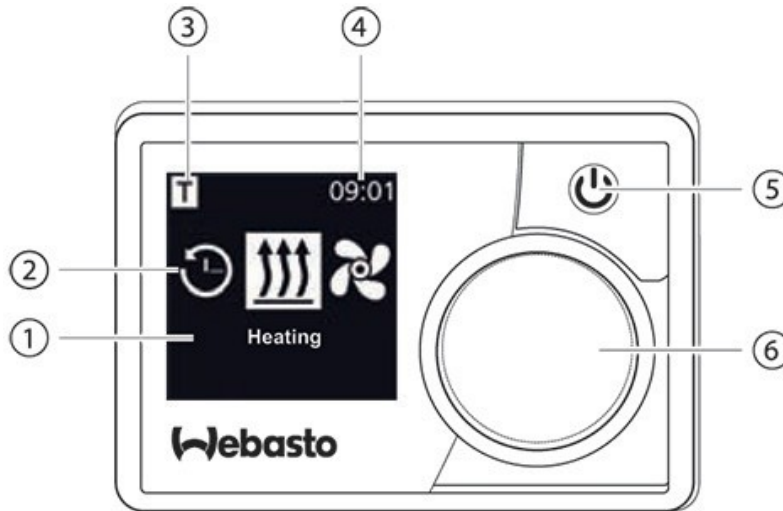

MultiControl Element and Menu Structure

NOTE: For more detailed information on the operation of the MultiControl control panel, refer to the operation guide located at www.techwebasto.com



- | | | | |
|---|---|---|--------------|
| 1 | Menu name | 2 | Menu symbol |
| 3 | Activated time settings, altitude correction* | 4 | Time |
| 5 | Quick-start button with status display | 6 | Control knob |

* - Optional

Button	Control and Function
	Quick-start button with status display
	Turn the control knob (turn/push button) to select a function.
	Press the control knob (turn/push button) for confirmation of the selected function.

Status	LED Backlight Color and State	
Heating mode	GREEN	ON
Ventilation mode	BLUE	ON
Switched off heater - control element is activated	WHITE	ON
Error - no heating mode	RED	FLASHING
Preprogrammed heating mode - control element in stand-by mode	GREEN	FLASHING
Preprogrammed ventilation mode - control element in stand-by mode	BLUE	FLASHING

NOTE: If a user does not make any inputs with the control unit within 60 seconds and the heater is switched off, the control unit will go into stand-by mode (display and LED are switched off).

Switching the heater ON using the quick-start button

The Quick Start button enables heating or ventilation with the push of one button . The operating mode can be adjusted to your personal preferences. Refer to the MultiControl operation manual on www.techwebasto.com.

Heating: Quick start button is programmed for heating



Heater starts. The display screen shows the symbol for "Heating" as well as the run-time remaining. The quick start button shows a green light.

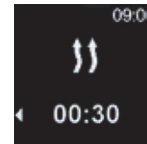

Ventilation: Quick start button is programmed for ventilation



Ventilation fan turns on. The fan speed and operating time are shown on the display. The quick start button shows a blue light.

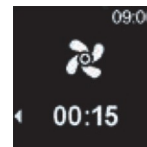

*Not available in North

Error Messages

Error messages regarding the heater will be displayed with the "F" or "H" designation displayed before the numerical error code. Explanations of these error codes can be found in the appropriate heater service manual. Error messages regarding the control element are displayed by means of "T" symbol. These error codes can be found in the operation manual for the MultiControl.

Error Codes

If error messages appear on the display, please contact Webasto technical support at 800-860-7866.



Feel the Drive

Fault Codes

NOTE: Not all Webasto coolant heaters show fault codes.

Fault Code	Error Message	Possible Cause	Recommended Action	Applicable Heaters
F00 or 0*	No error Heater Lock-out ¹	<ul style="list-style-type: none"> Fuses Electrical wiring Heater lock-out Control Unit Defective 	<ul style="list-style-type: none"> Check fuses Check control element Check W-bus connections (yellow) 	Thermo Pro 50 ECO Thermo Pro 90
F01 or 1*	No start	<ul style="list-style-type: none"> Fuel system Combustion air/exhaust pipe Burner unit 	<ul style="list-style-type: none"> Check fuel level Check fuel filter Check fuel extractor and fuel line for leaks Bleed fuel system Check combustion air/exhaust pipe 	Thermo 230/300/ 350 Thermo 50 Thermo Pro 50 ECO Thermo 90 ST Thermo Pro 90
F02 or 2*	Flame failure/ Flame abort	<ul style="list-style-type: none"> Fuel system Burner unit 	<ul style="list-style-type: none"> Check fuel level Check fuel filter Check fuel extractor and fuel lines for leaks Bleed fuel system Clean/replace burner 	Thermo 230/300/ 350 Thermo 50 Thermo Pro 50 ECO Thermo 90 ST Thermo Pro 90
F03 or 3*	Supply Voltage Too High/ Low	<ul style="list-style-type: none"> Power supply 	<ul style="list-style-type: none"> Check battery Check electrical connections 	Thermo 230/300/ 350 Thermo 50 Thermo Pro 50 ECO Thermo 90 ST Thermo Pro 90
F04 or 4*	Premature flame detection	<ul style="list-style-type: none"> Foreign light detected during run-up or run-down² Flame sensor defective Exhaust temperature sensor defective¹ 	<ul style="list-style-type: none"> Check flame monitor Check exhaust gas temperature sensor¹ 	Thermo 230/300/ 350 Thermo 50 Thermo Pro 50 ECO Thermo 90 ST Thermo Pro 90
F05 or 5*	Flame sensor defective ²	<ul style="list-style-type: none"> Defective Flame sensor 	<ul style="list-style-type: none"> Check flame sensor 	Thermo 230/300/ 350 Thermo 50 Thermo 90 ST
F06 or 6*	Temperature sensor open- or short-circuit	<ul style="list-style-type: none"> Wiring Coolant temperature sensor defective 	<ul style="list-style-type: none"> Check wiring/sensor for resistance Check operation of sensor 	Thermo 230/300/ 350 Thermo 50 Thermo Pro 50 ECO Thermo 90 ST Thermo Pro 90
F07 or 7*	Metering/Fuel pump defective Fuel solenoid defective ²	<ul style="list-style-type: none"> Wiring Defective pump 	<ul style="list-style-type: none"> Check wiring for damage Check fuel pump for operation 	Thermo 230/300/ 350 Thermo 50 Thermo Pro 50 ECO Thermo 90 ST Thermo Pro 90
F08 or 8*	Combustion air fan defective/ blocked	<ul style="list-style-type: none"> Wiring Blockage Defective fan 	<ul style="list-style-type: none"> Check wiring for damage Remove blockage Replace fan 	Thermo 230/300/ 350 Thermo 50 Thermo Pro 50 ECO Thermo 90 ST Thermo Pro 90

F09 or 9*	Circulation pump defective ² Glow plug defective	<ul style="list-style-type: none"> Defective pump or wiring² Defective glow plug or wiring 	<ul style="list-style-type: none"> Check pump operation and wiring Check glow plug operation and wiring 	Thermo 230/300/350 Thermo 50 Thermo Pro 50 ECO Thermo 90 ST Thermo Pro 90
F10 or 10*	Temperature limiter defective/overheating ² Overheating	<ul style="list-style-type: none"> Temperature limiter defective² Heater overheating Overheat protection defective 	<ul style="list-style-type: none"> Replace temperature limiter Check coolant level/bleed coolant Check coolant pump operation Check temperature protection wiring Check operation of overheat protection, replace as necessary 	Thermo 230/300/350 Thermo 50 Thermo Pro 50 ECO Thermo 90 ST Thermo Pro 90
F11 or 11*	Igniter box defective ² Circulation pump defective	<ul style="list-style-type: none"> Defective igniter box/electrodes² Pump wiring Defective pump 	<ul style="list-style-type: none"> Replace igniter box/electrodes Repair wiring Replace pump 	Thermo 230/300/350 Thermo 50 Thermo Pro 50 ECO Thermo 90 ST Thermo Pro 90
F12 or 12*	Heater lock-out ²	<ul style="list-style-type: none"> Repeated malfunction or flame-out² Main battery switch defective 	<ul style="list-style-type: none"> Repair cause of malfunction² Check wiring for damage Check battery disconnect 	Thermo 230/300/350 Thermo Pro 50 ECO Thermo Pro 90
F13 or 13*	Operation of vehicle fan defective Vehicle fan short circuit	<ul style="list-style-type: none"> Wiring Vehicle fan relay defective 	<ul style="list-style-type: none"> Check wiring for damage Check vehicle fan relay operation 	Thermo Pro 50 ECO Thermo Pro 90
F14 or 14*	Overheat sensor short circuit	<ul style="list-style-type: none"> Wiring Overheating protection sensor defective 	<ul style="list-style-type: none"> Check wiring for damage Check overheat protection for proper operation 	Thermo Pro 50 ECO Thermo Pro 90
F15 or 15*	Glow or ignition element circuit defective	<ul style="list-style-type: none"> Wiring Glow plug defective 	<ul style="list-style-type: none"> Check wiring for damage Check operation of glow plug 	Thermo Pro 50 ECO Thermo Pro 90
F16 or 16*	Exhaust gas temperature high	<ul style="list-style-type: none"> Exhaust gas temperature sensor defective Heater fouled 	<ul style="list-style-type: none"> Check wiring Check operation of exhaust gas temperature sensor Check burner and heat exchanger for fouling 	Thermo Pro 50 ECO Thermo Pro 90
F17 or 17*	Exhaust gas temperature sensor open or short circuit	<ul style="list-style-type: none"> Wiring Exhaust gas temperature sensor defective 	<ul style="list-style-type: none"> Check wiring for damage Check operation of exhaust gas temperature sensor, replace if necessary 	Thermo Pro 50 ECO Thermo Pro 90
<p>* - Indicator lamp of control element flashing: number of long flashes after 5 rapid flashes ** - Were applicable 1 - Thermo Pro 50 ECO 2 - Thermo 230/300/350</p>				

Fault Lock-Out (interlock)

Heater Lockout Procedure

The control unit continuously monitors the heater operation. The control unit identifies errors on individual heater components and faults during operation. Should the control unit experience component errors and operational faults, the heater may be shut down.

Causes:

The heater is shut down (fault lock-out) if:

No or incorrect start

Temperature sensor defective

Overheating sensor interrupt or short circuit

Overheating sensor installed incorrectly

Ceramic glow pin interrupt or short circuit

Fan motor overload or blocked or short circuit or interrupt

Error in the fuel metering pump or circuit

Under voltage or over voltage for longer than 20 seconds.

Control unit defective

Overheating

Effects:

The fuel supply is stopped if the heater overheats.

The heater continues to run in the same way as if it is switched off manually.

After the heater stops the control unit may set in fault lock-out mode.

Heater Lock out Reset Procedure:

1. Switch the heater ON
2. Within 10 seconds disconnect power from the heater (unplug the harness, disconnect the battery, remove the fuse)
3. Wait 10 seconds
4. Switch the heater OFF
5. Reconnect power
6. Switch the heater ON
7. Rectify the cause of the fault

IMPORTANT: Heater fault codes can be read using PC Diagnostics, however, the heater lockout reset must be manually performed using the procedure stated above.

If you have any questions, contact our technical support team at:

(800) 860-7866 or via email at: info-us@webasto.com.

Limited Non-Transferable Warranty

If an error occurs, first check the fuse and plug connections to ensure that they are in proper condition and connected correctly.

If the actions described below do not rectify the error, have the heater checked by Webasto-trained personnel.

Heater unit cuts out automatically

Cause	Remedy
No combustion after start and repeat start	Switch heater unit off (for at least 2 seconds) and then on again
Flame extinguishes during operation	Switch heater unit off (for at least 2 seconds) and then on again
Heater unit overheats and indicator flashes	Make sure that water/coolant can flow freely, allow heater unit to cool down, Switch heater unit off (for at least 2 seconds) and then turn on again
Vehicle voltage too low	Charge battery Switch heater unit off (for at least 2 seconds) and then turn on again

Heater unit emits black smoke

Cause	Remedy
Combustion air and/or exhaust system blocked	Check combustion air and exhaust system for blockage

Webasto Thermo & Comfort North America, Inc. (hereinafter referred to as Webasto) warrants their heaters and heater kits against defects in material and workmanship for two (2) years effective at the time of installation or vehicle registration date for original equipment installation (OEM). This warranty period may not exceed three (3) years from the original date of sale by Webasto. This warranty period may be superseded by written contractual agreements.

All models are limited to 2,000 maximum operating hours.

Replacement parts are covered for six (6) months or the remainder of the original warranty period, whichever is longer.

The intent of the Webasto warranty is to protect the original end-user of the heater from defects and provide free repair and replacement of defective parts in the manner provided herein. During the warranty period, the exclusive remedy will be for Webasto, at their discretion, to repair or replace those parts which are demonstrated to be defective in material or workmanship.

While warranty is provided to the "original end-user", it is to be administered and serviced through an authorized Webasto dealer in accordance with the Webasto warranty policy or contractual agreement between Webasto and a second party.

To locate the nearest Webasto authorized dealer for warranty service:

visit <http://www.techwebasto.com> or call (800) 860-7866 in USA, (800) 667-8900 in Canada.

The heater can be registered by visiting www.techwebasto.com or by scanning the code.

A proof of purchase is required for all heaters that are not registered.





Webasto Thermo & Comfort N.A., Inc
15083 North Road
Fenton, MI 48430

Technical Assistance Hotline
USA: (800) 860-7866
Canada: (800) 667-8900

www.webasto.us
www.techwebasto.com

Org. 10/2017

Rev. 10/2020

P/N: 5012725D