

E-Z Power Tonno Cover

Service and Repair Manual

Table of Contents

1. Introduction

1.1	Scope and Purpose	S-1
1.2	Meaning of Warning, Caution, and Attention Headings	S-1
1.3	Additional Documentation to be Used	S-1
1.4	General Safety Regulations and Information	S-1
1.4.1	General Safety Notes	S-1

2. General Description

2.1	Assembly Break-out	S-2
-----	------------------------------	-----

3. Service and Repair Instructions

3.1	Removing and Installing Tonno Cover Assembly	S-4
3.2	Track Replacement	S-5
3.3	RH or LH Lifter Replacement	S-8
3.4	Slider Assembly Replacement	S-10
3.5	Drive Assembly Replacement	S-12
3.6	RKE Receiver Set Replacement	S-14
3.7	Decorative Cap Replacement	S-16
3.8	Cover Assembly - Complete	S-17
3.9	Drive Cable Replacement	S-20
3.10	Cover with Light Assembly Replacement	S-24
3.11	Reinforcement Assembly - Rear	S-26
3.12	Front Rail Assembly Replacement	S-31
3.13	Cover Fabric Replacement	S-34
3.14	Light Assembly Replacement	S-38
3.15	Clamp Set Replacement	S-39

4. Service Parts

4.1	Service Parts	S-42
-----	-------------------------	------

1. Introduction

1.1 Scope and Purpose

This manual is intended to support authorized Webasto trained distributors, dealers and servicing personnel in the servicing and repair of the E-Z Power Tonno Cover.

Webasto Product North America, Inc. does not recommend the servicing and repair of Webasto products by untrained, unauthorized personnel or end-users.

Servicing and repair of Webasto products by untrained, unauthorized personnel and end-users will release Webasto Product North America, Inc. and Webasto authorized distributors, dealers and their personnel from responsibility for damage to Webasto product, collateral property damage and personal injury that may result.

Any use, operation, installation, modification or application of the product not described in Webasto manuals, or subjecting the product to extreme or unusual conditions beyond the limits of specified performance characteristics is misuse of the product.

Failure to comply with all servicing and repair instructions is a misuse of Webasto product. The same applies for repairs without using genuine Webasto service parts. This will void the products "Official Marks of Conformity."

1.2 Meaning of Warning, Caution, and Attention Headings

Warning, Caution and Attention headings in this manual have the following meaning:

⚠ WARNING
This heading is used to highlight that non-compliance with instructions or procedures can result in serious injuries or death to personnel.

⚠ CAUTION
This heading is used to highlight that non-compliance with instructions or procedures may cause injury to personnel or damage to equipment.

ATTENTION!
This heading is used to highlight and draw specific attention to important information.

1.3 Additional Documentation to be Used

This manual contains all of the information and procedures necessary for the servicing and repair of the E-Z Power Tonno Cover.

The use of additional documentation is normally not required. Vehicle specific installation guides (when available) and part listings may be useful as complementary information.

1.4 General Safety Regulations and Information

The general safety regulations for the prevention of accidents and relevant safety instructions must be observed at all times.

The specific safety regulations applicable to this manual are highlighted in the individual chapters by Warning, Caution and Attention notations (see section 1.2).

1.4.1 General Safety Notes

Personal safety equipment such as safety glasses and proper attire should be worn during the servicing, repairing, removal and installation of the E-Z Power Tonno Cover.

The E-Z Power Tonno Cover may only be installed on motor vehicles as specified in the product application and installation documentation.

The function of any parts vital for vehicle operation must not be impaired.

Observe proper operating conditions and instructions as described in the operating instructions supplied with the E-Z Power Tonno Cover.

⚠ CAUTION
Never operate the E-Z Power Tonno Cover while the vehicle is in motion. Product damage may result.

2. General Description

2.1 Assembly Break-out

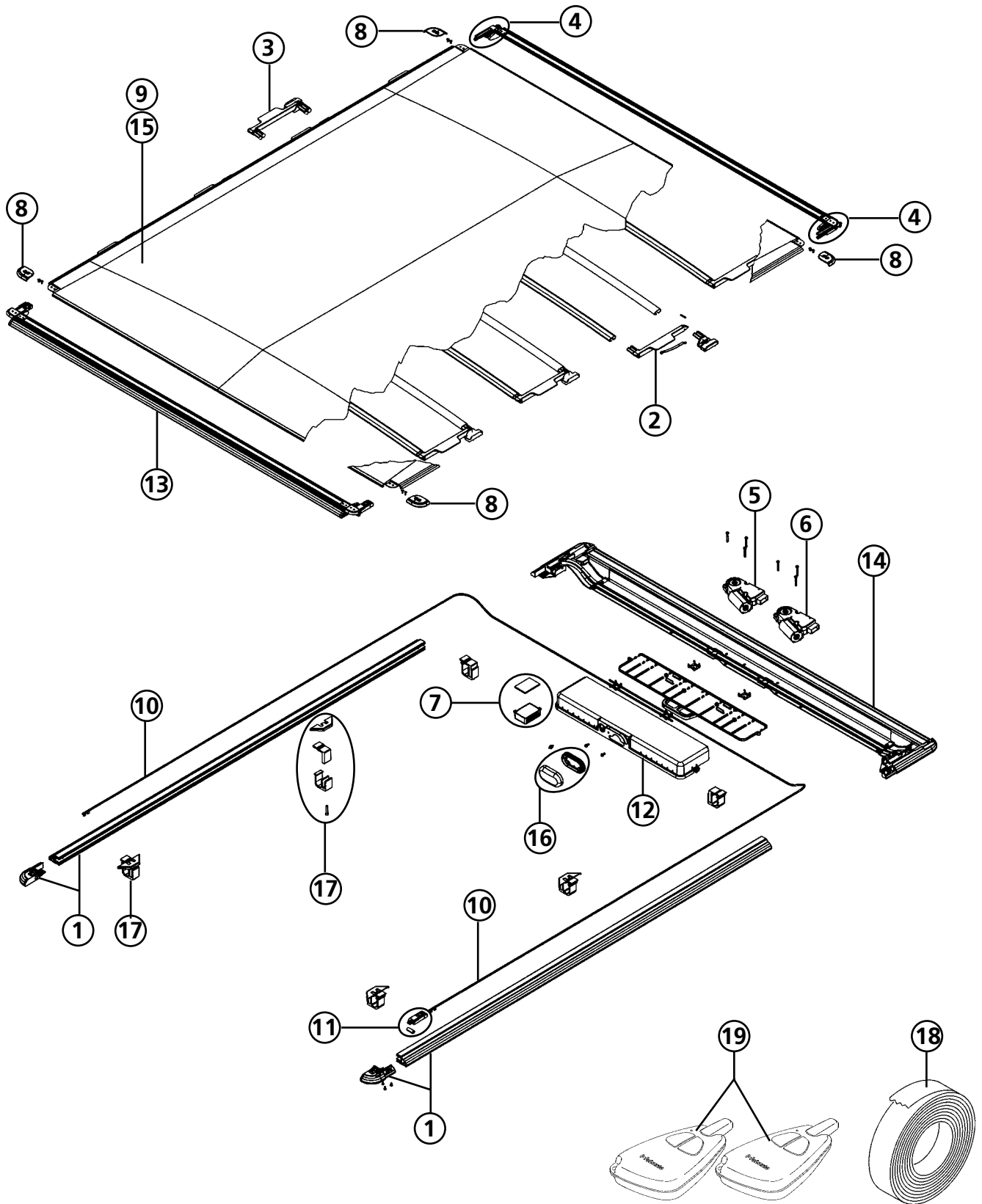

Item	Description	Remarks
1	Track Assembly	See section 3.2 for details.
2	RH Lifter Assembly	See section 3.3 for details.
3	LH Lifter Assembly	See section 3.3 for details.
4	Slider Assembly	See section 3.4 for details.
5	Master Drive Assembly	See section 3.5 for details.
6	Slave Drive Assembly	See section 3.5 for details.
7	RKE Receiver	See section 3.6 for details.
8	Decorative Corner Cap	See section 3.7 for details.
9	Cover Assembly - Complete	See section 3.8 for details.
10	Drive Cables	See section 3.9 for details.
11	Trolley Assembly	See section 3.9 for details.
12	Motor Cover with Light Assembly	See section 3.10 for details.
13	Reinforcement Assembly - Rear	See section 3.11 for details.
14	Front Rail Assembly	See section 3.12 for details.
15	Cover Fabric	See section 3.13 for details.
16	Light Assembly	See section 3.14 for details.
17	Clamp Set	See section 3.15 for details.
18	Foam Tape	
19	Remote Key Fob	

3.1 Removing and Installing Tonno Cover Assembly

Removing Tonno Cover

1. Open the tonno cover 3 to 4 inches (8 to 10 cm) from the full closed position.
2. Disconnect the 2 pin connector from the tonno main wire harness. See figures S-1.
3. Remove the six (6) lower clamp arm retainer screws and lower clamp arms. See figure S-2.
4. Remove the tonno cover from the truck bed with help of an assistant and place it on a clean work surface.

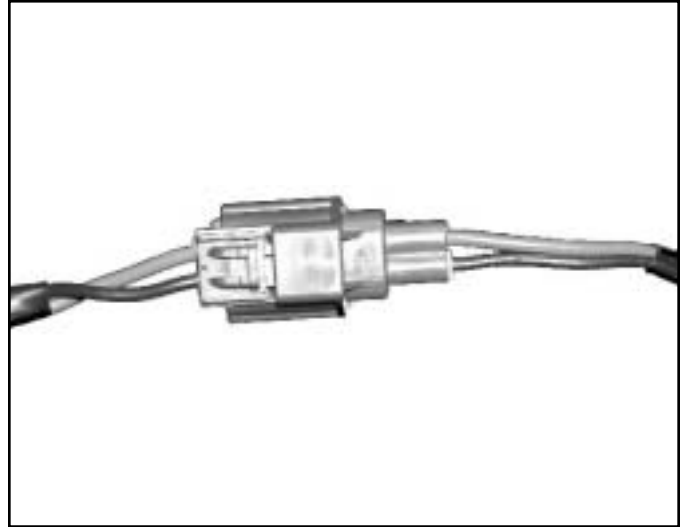

Figure S-1

Installing Tonno Cover

5. With help of an assistant, place tonno cover into position on the truck bed.
6. Reconnect the 2 pin connector on the main wire harness. See figure S-1.
7. Reposition the upper clamp pieces in their original position and install the six (6) lower clamp arms and retaining machine screws (Do not tighten). See figure S-2.
8. Operate the tonno completely open and closed once to ensure track adjustment before tightening the clamps.
9. Tighten the clamp arm retaining screws.

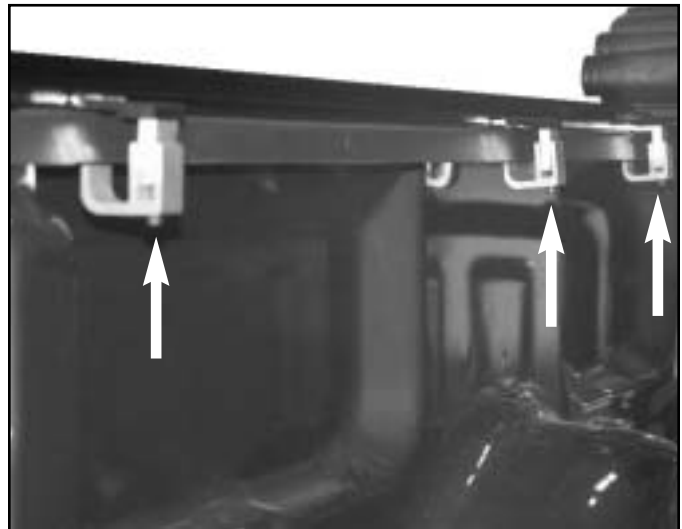

Figure S-2

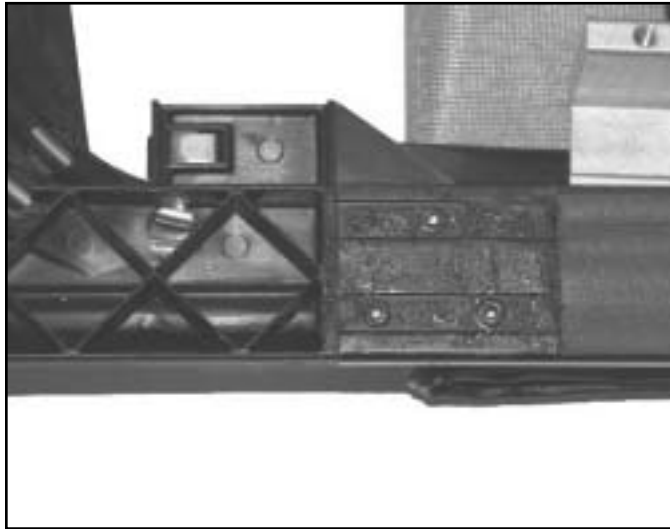

Figure S-3

3.2 Track Replacement

1. Remove tonno cover assembly from truck bed as described in section 3.1, steps 1 through 4.
2. With the help of an assistant, place the tonno cover bottom side up on a clean work surface.
3. Peel back the foam tape 11 inches (28 cm) from the front rail to the track on the side being replaced to expose the three (3) retaining rivets. See figure S-3.

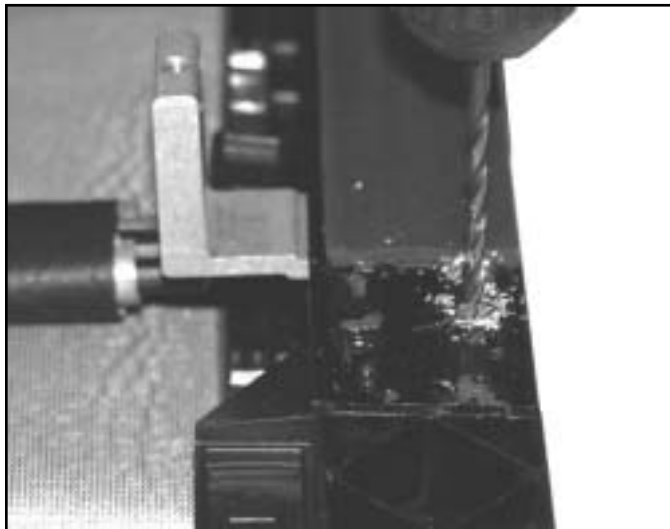

Figure S-4

4. Drill out the three (3) retaining rivets using caution not to drill into the track. See figure S-4.

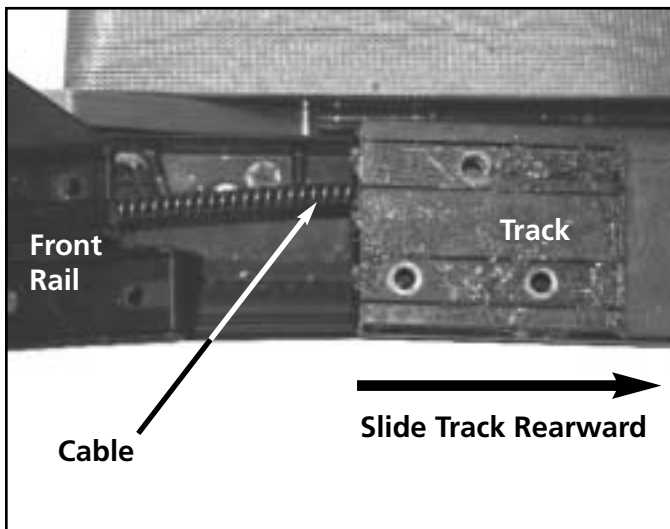

Figure S-5

5. Slide the track rearward away from the front rail disengaging it from the lifters, trolley and cable. See figures S-5 and S-6.

Note: Reference mark which guide opening that the cable is in for later installation of the new track.

6. Slide the trolley and cable into the track and slide the track forward over the lifters onto the front rail. See figure S-6.

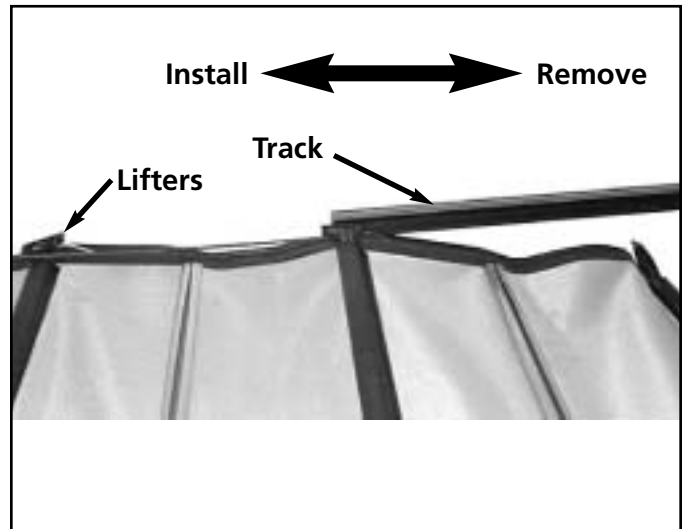

Figure S-6

7. Install the three (3) rivets into the front of the track and fasten with a rivet gun. See figure S-7.



Figure S-7

8. Install the end cap into the end of the track.
9. Install the three (3) rivets retaining the end cap to the track and fasten with a rivet gun. See figure S-8.

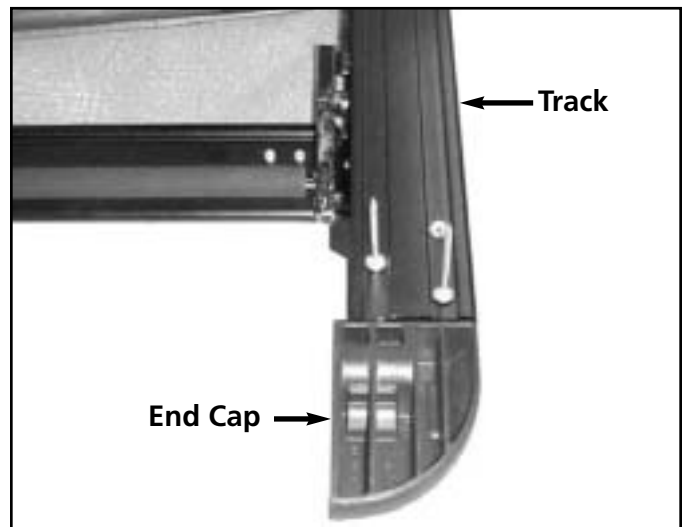

Figure S-8

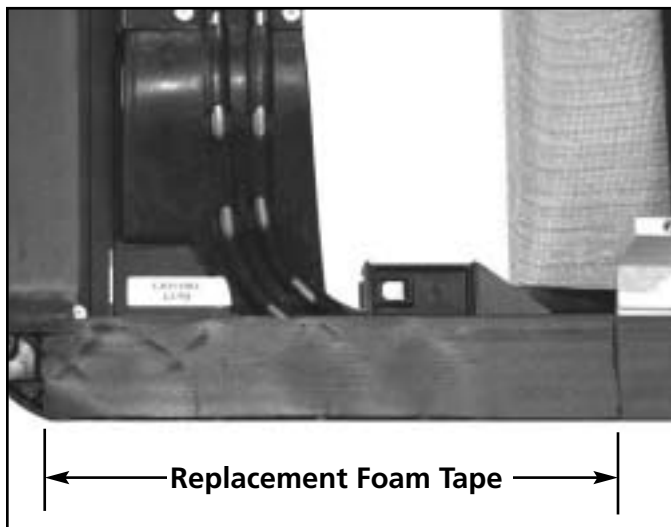

Figure S-9

10. Measure and cut foam tape to cover the track and rail and apply the foam tape to the track and rail. See figure S-9.

11. Install tonno cover assembly on truck bed as described in section 3.1, steps 5 through 9.

3.3 RH or LH Lifter Replacement

1. Remove tonno cover assembly from truck bed as described in section 3.1, steps 1 through 4.
2. With the help of an assistant, place the tonno cover bottom side up on a clean work surface.
3. Identify which side has a broken lifter assembly.

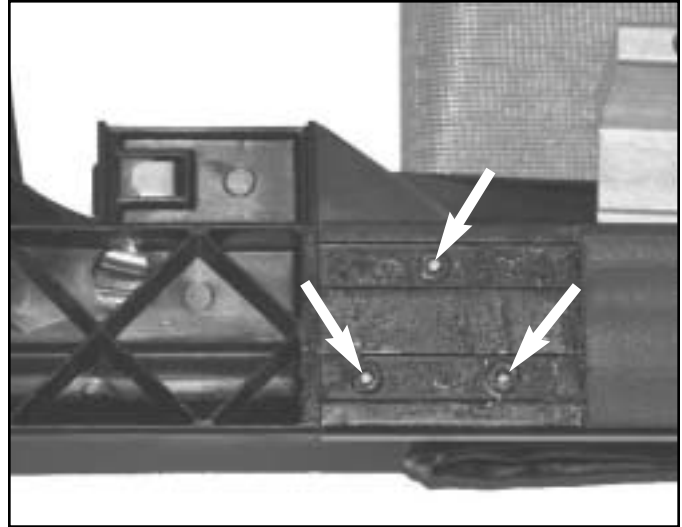

Figure S-10

4. Peel back the foam tape 11 inches (28 cm) from the front rail to the track on the side being replaced to expose the three (3) retaining rivets. See figure S-10.
5. Drill out the three (3) retaining rivets using caution not to drill into the track. See figure S-11.
6. Slide the track away from the rail until the broken lifter is exposed. See figure S-12.

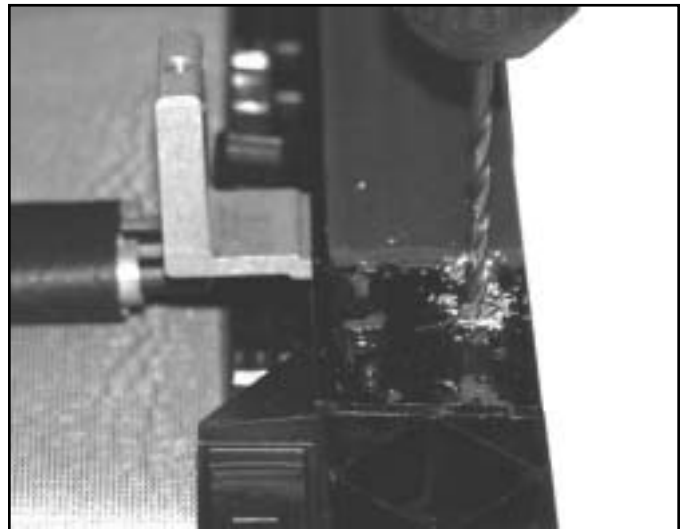

Figure S-11

7. Detach the broken lifter from the reinforcement and primary bows by pulling the lifter away from the cover.
8. Insert the new lifter into the reinforcement and primary bows by pushing the lifter in towards the cover.
9. Slide the track back onto the lifters by pushing it forward towards the rail. See figure S-12.

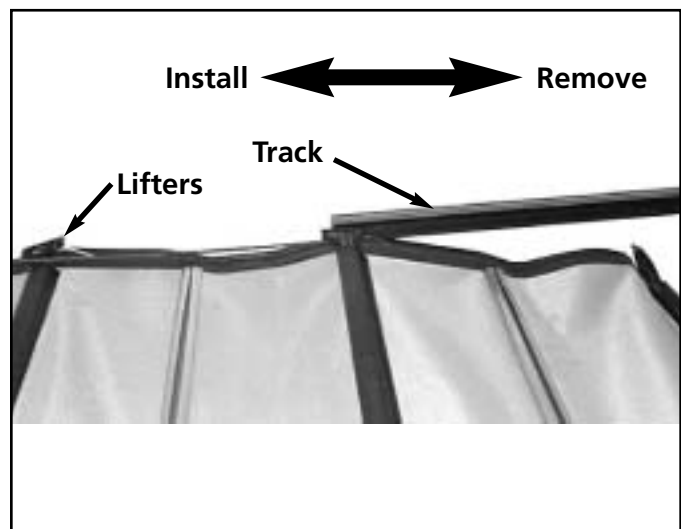

Figure S-12



Figure S-13

10. Insert the track onto the front rail and install three (3) rivets. See figures S-13 and S-14.



Figure S-14

11. Fasten the rivets with a rivet gun. See figures S-13 and S-14.

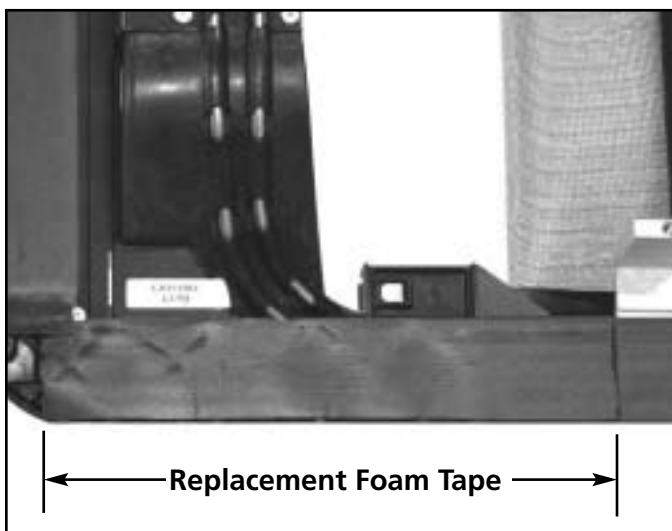

Figure S-15

12. Measure and cut foam tape to cover the area exposed during step 4. See figure S-15.
13. Install tonno cover assembly on truck bed as described in section 3.1, steps 5 through 9.

3.4 Slider Assembly Replacement

1. Remove the two (2) T-20 Torx slider retainer screws from the front rail. See figure S-15.
2. Remove the slider retainers by pulling them towards the cab of the truck.

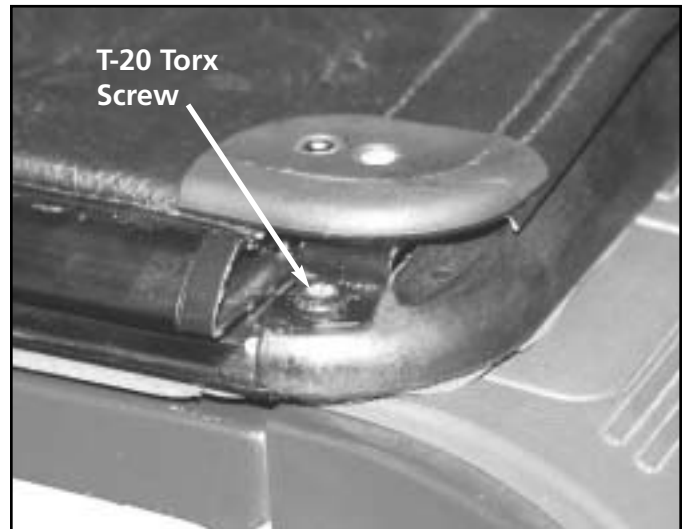

Figure S-15

3. Lift the cover up and back exposing the front rail. See figure S-16.

⚠ WARNING
Slider spring is under slight tension. Exercise care while releasing spring. Wear safety glasses during this procedure to avoid possible eye injury.

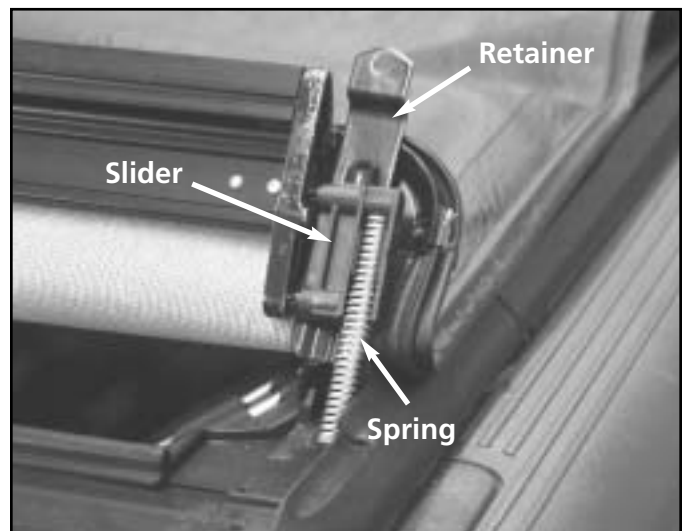

Figure S-16

4. Remove the slider and slider spring from each side of the front reinforcement. See figure S-17.

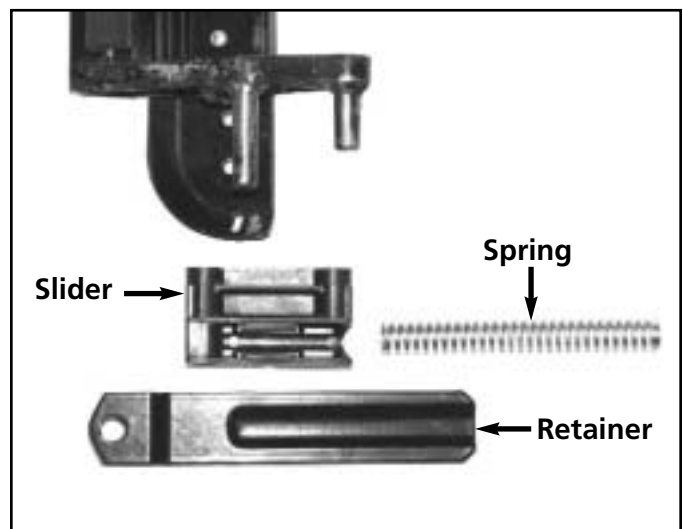

Figure S-17

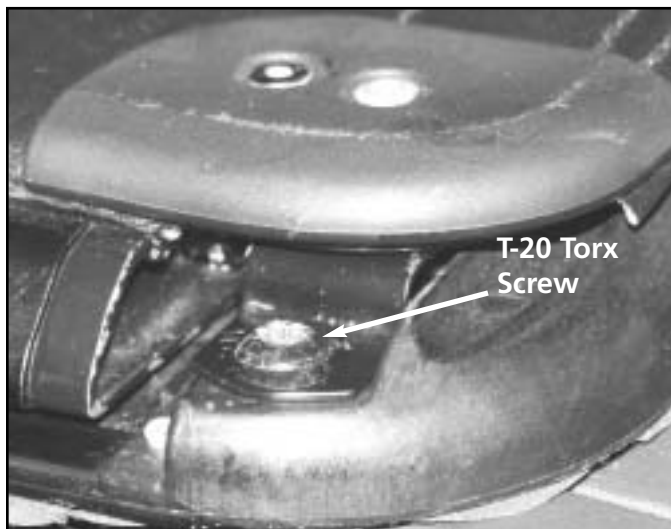

Figure S-18

5. Install the new slider onto the front reinforcement and then the spring into the slider.
6. Move the cover back down onto the rail using care to set the springs into the guide area of the rail. Refer back to figure S-16.
7. Insert the slider retainers into the front rail over the slider spring and slider. Refer back to figure S-16.
8. Install the two (2) T-20 Torx slider retainer screws into the front rail and fasten. See figure S-18.

3.5 Drive Assembly Replacement

1. Remove the two (2) T-20 Torx screws from the front rail and slider retainers. See figure S-19.

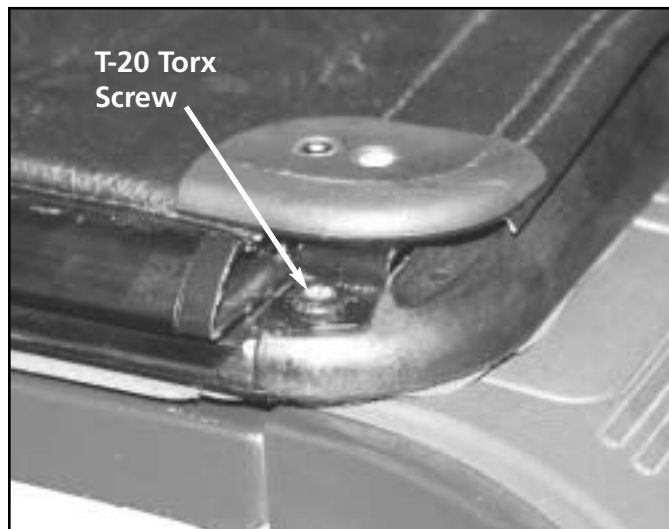

Figure S-19

2. Lift the cover back and away from the front rail being careful not to loose the slider, slider retainer and slider spring. See figure S-20.

⚠ WARNING

Slider spring is under slight tension. Exercise care while releasing spring. Wear safety glasses during this procedure to avoid possible eye injury.

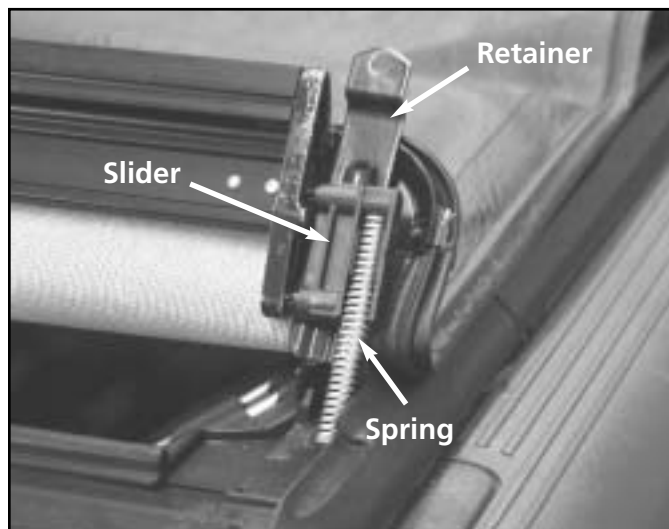

Figure S-20

3. Remove the four (4) T-20 Torx screws from the motor cover and set the motor cover aside. See figure S-21.

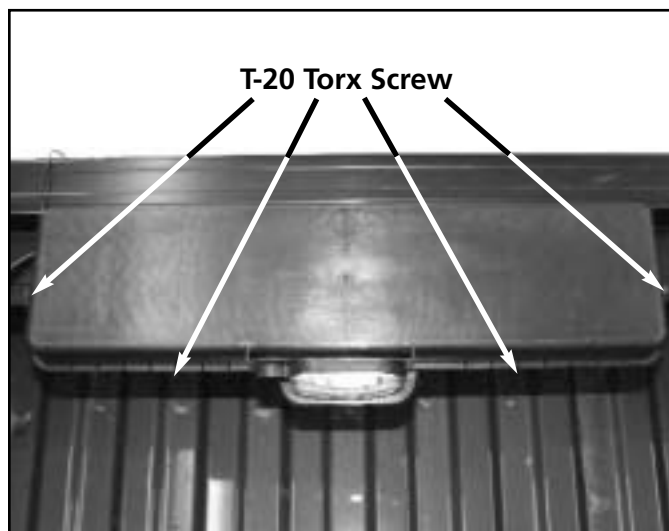

Figure S-21

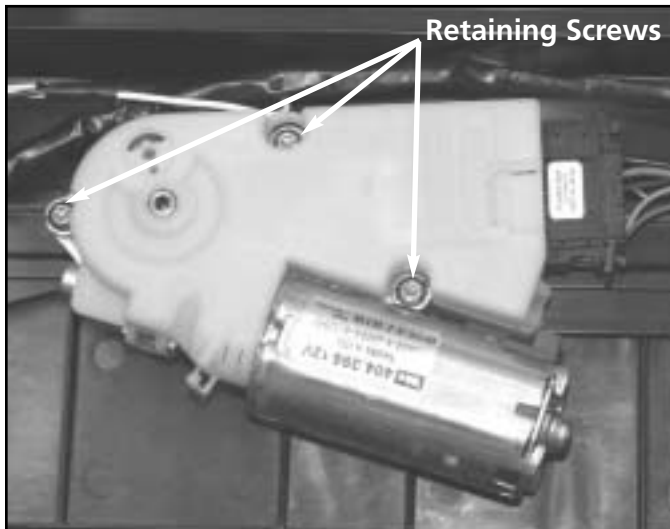

Figure S-22

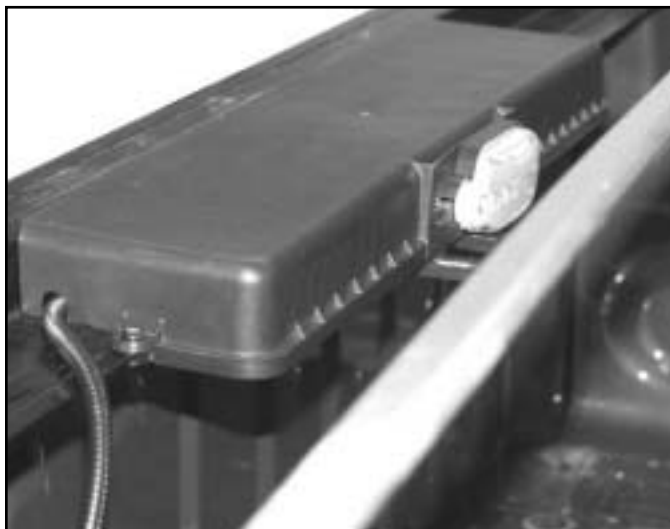

Figure S-23

4. After diagnosing the faulty drive assembly, remove the three (3) motor retaining screws. See figure S-22.
5. Disconnect the electrical connector on the drive assembly.
6. Remove the drive assembly from the front rail.
7. Install the new drive assembly onto the front rail.
8. Reconnect the electrical connector to the drive assembly.
9. Install and fasten the three (3) drive assembly retaining screws. See figure S-22.
10. Position the motor cover onto the front rail, install the four (4) T-20 Torx retaining screws and fasten. See figure S-23.
11. Move the tonno cover over the motor cover and front rail. Be sure the slider, slider spring and slider retainer are installed. Refer back to figure S-20.
12. Install the two (2) T-20 Torx screws through the slider retainer onto the front rail and fasten. Refer back to figure S-19.
13. If the Master drive assembly has been replaced, it will be necessary to perform the initialization procedure. If the Slave drive assembly has been replaced, no further action is required.

3.6 RKE Receiver Set Replacement

1. Remove the two (2) T-20 Torx slider retainer screws from the front rail. See figure S-24.

⚠ WARNING

Slider spring is under slight tension. Exercise care while releasing spring. Wear safety glasses during this procedure to avoid possible eye injury.

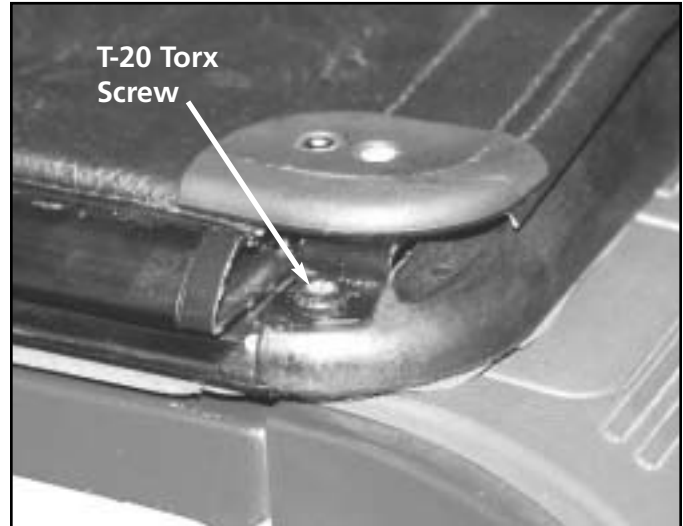

Figure S-24

2. Remove the slider retainers and pull the cover back and up in order to expose the motor cover. See figure S-25.

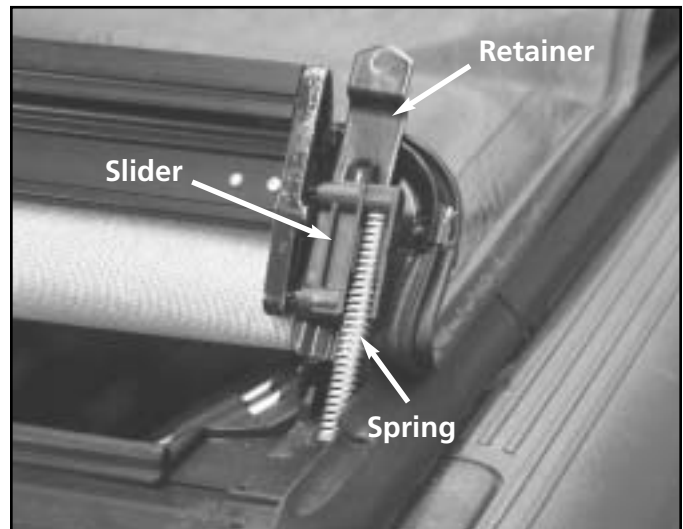

Figure S-25

3. Remove the four (4) T-20 Torx motor cover retaining screws. See figure S-26.
4. Remove the motor cover and position it upside down in order to expose the RKE module.
5. Disconnect the RKE module wire harness connector. See figure S-27.

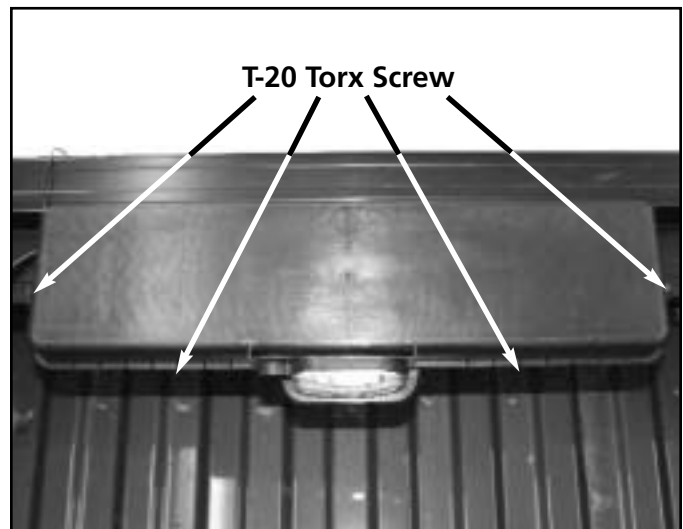

Figure S-26

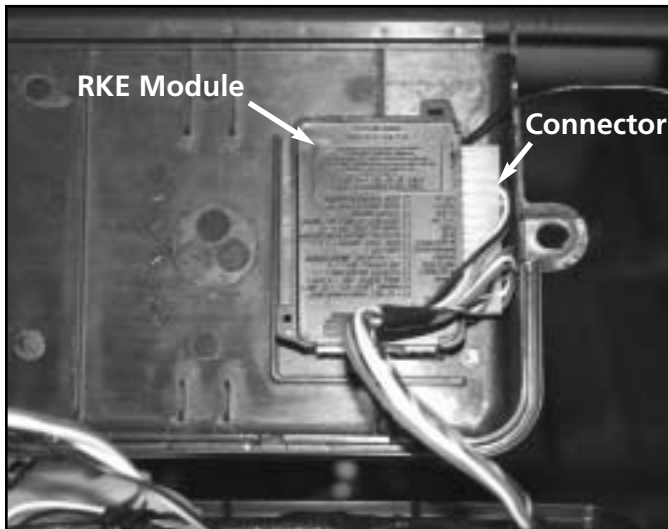

Figure S-27

6. Peel the RKE module away from the adhesive tape.
7. Remove the RKE module and note the routing of the antenna.
8. Install the new RKE module in the same position using the adhesive tape and routing the antenna in the same location as before.
9. Connect the RKE module wire harness connector.
10. Install the motor cover onto the rail assembly.
11. Install the four (4) T-20 Torx screws onto the motor cover and fasten. Refer back to figure S-26.
12. Fold the tonno cover over the rail and install the sliders, slider springs and slider retainers into the front rail. Refer back to figure S-25.
13. Install the two (2) T-20 Torx screws through the slider retainers into the front rail and fasten. Refer back to figure S-24.
14. Initialize the key FOBS to the new RKE module by pressing and holding the red button on the motor cover for five (5) seconds. The light in the motor cover will flash to indicate that the RKE module is in the learn mode. Press one of the buttons on each FOB to be programmed. The light should flash twice every time a key FOB is initialized.

3.7 Decorative Cap Replacement

1. Close the tonno cover completely.
2. Drill out the two (2) rivets on the decorative cap. See figure S-28.
3. Remove the decorative cap.



Figure S-28

4. Position the new decorative cover onto the reinforcement.
5. Install two (2) new rivets through the decorative caps. See figure S-29.
6. Fasten the rivets with a rivet gun. See figure S-29.



Figure S-29

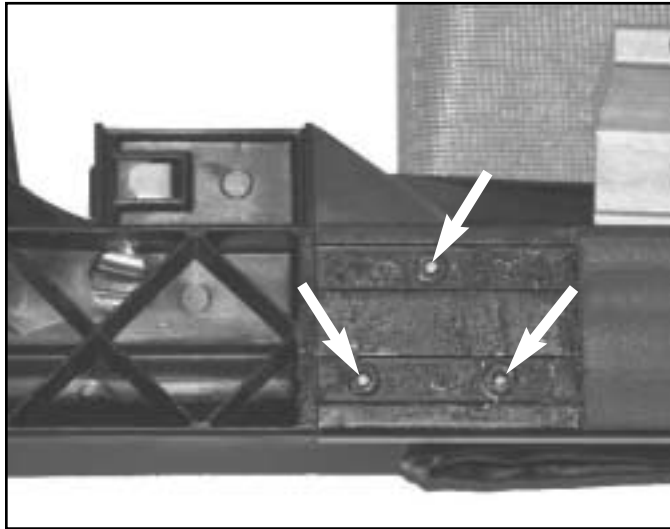

Figure S-30

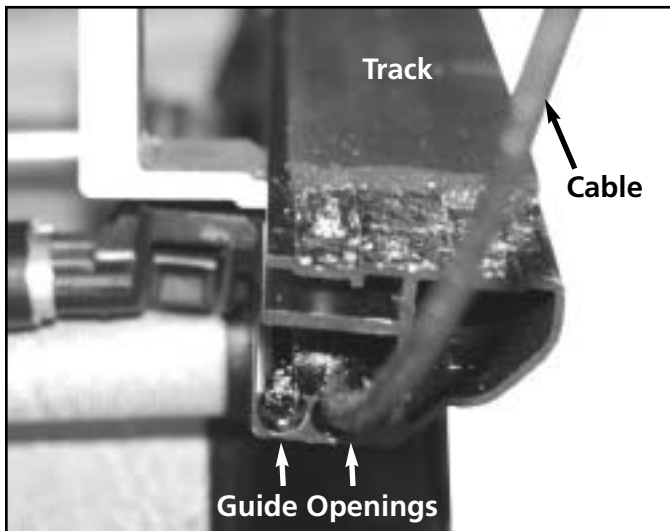

Figure S-31

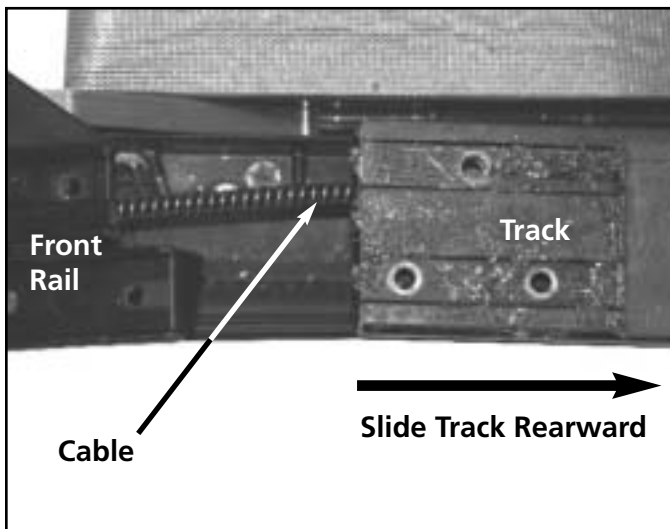

Figure S-32

3.8 Cover Assembly - Complete

1. Remove tonno cover assembly from truck bed as described in section 3.1, steps 1 through 4.
2. With the help of an assistant, place the tonno cover bottom side up on a clean work surface.
3. Peel back the foam tape 11 inches (28 cm) from the front rail to the track to expose the three (3) retaining rivets. See figure S-30.
4. Drill out the three (3) retaining rivets using caution not to drill into the track. See figures S-30 and S-31.
5. Slide the track rearward away from the front rail disengaging it from the lifters, trolley and cable.

Note: Reference mark which guide opening that the cable is in for later installation of the rail.

See figures S-31 and S-32.
6. Fold the front rail and tonno cover fabric over so that the top side is facing up.
7. Remove the two (2) slider retainer T-20 Torx screws from the front rail. See figure S-33.
8. Remove the slider retainers and pull the tonno cover fabric back and up in order to expose the motor cover. See figure S-34.

9. Disengage the front lifters on the front rail from the cover bow and remove the cover assembly. See figure S-35.

10. Install the new cover by inserting the lifters on the front rail into the first bow of the cover.

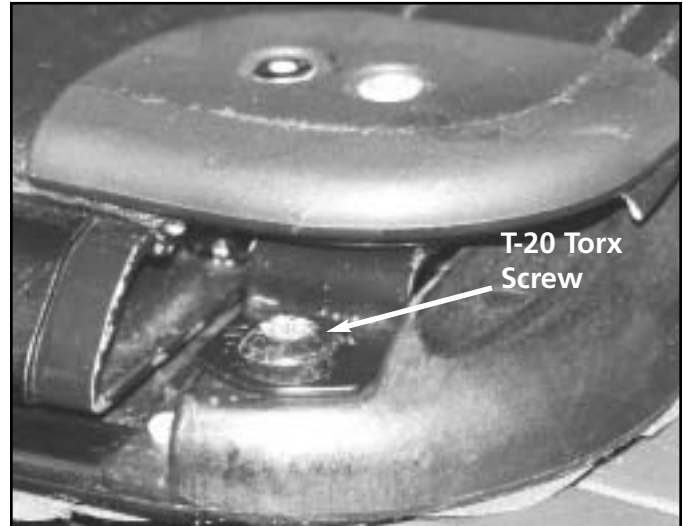

Figure S-33

11. Fold the cover over the rail and install the sliders, slider springs and slider retainers into the front rail. See figure S-34.

12. Install the two (2) T-20 Torx screws through the slider retainers into the front rail and fasten. See figure S-33.

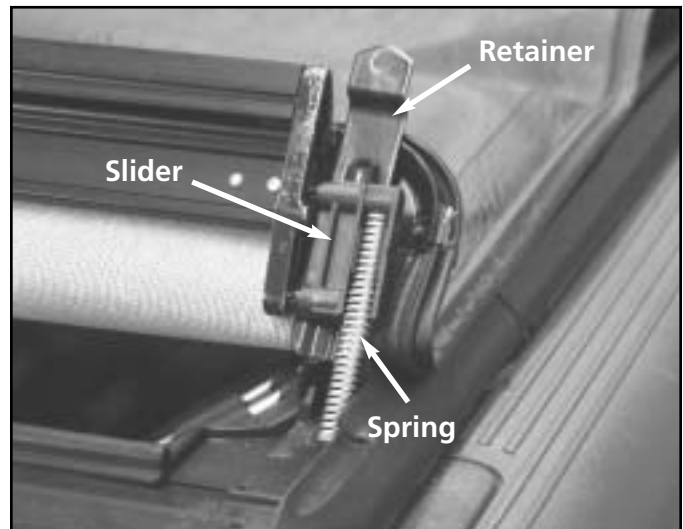

Figure S-34

13. Turn the tonno cover fabric and rail over so that the bottom side is facing up.

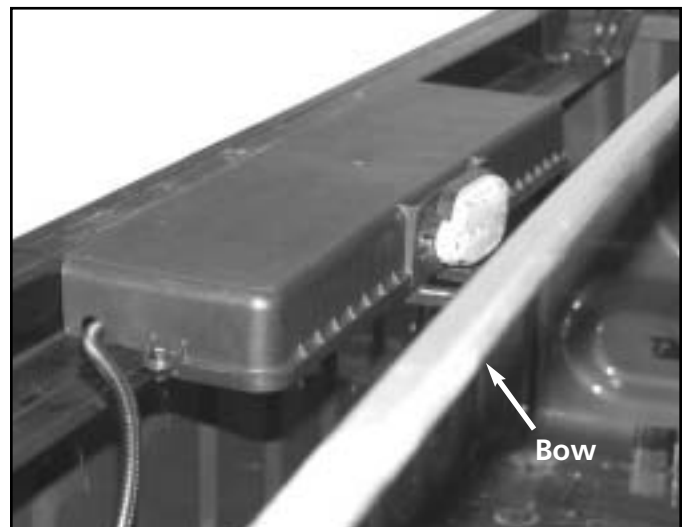

Figure S-35



Figure S-36

14. Slide the trolley and cable into the track and slide the track forward over the lifters onto the front rail. See figures 36 and S-37.



Figure S-37

15. Install the three (3) rivets into the front of each track and fasten with a rivet gun. See figure S-37.

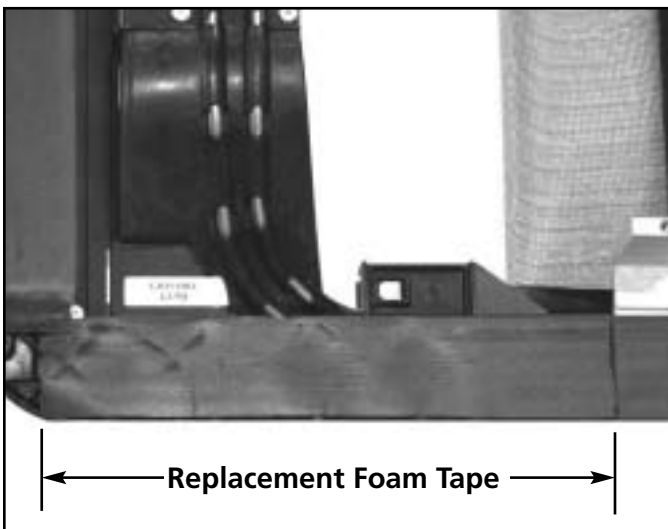

Figure S-38

16. Cover the exposed areas of the track and rail with foam tape. See figure S-38.
17. Install tonno cover assembly on truck bed as described in section 3.1, steps 5 through 9.

3.9 Drive Cable Replacement

1. Remove the front two (2) T-20 Torx bolt located on either side of the front rail. See figure S-39.
2. Lift the front cover reinforcement up and back being careful not to loose the sliders, slider springs and slider retainers. See figure S-40.

⚠WARNING

Slider spring is under slight tension. Exercise care while releasing spring. Wear safety glasses during this procedure to avoid possible eye injury.

3. Remove the four (4) T-20 Torx motor cover retainer bolts from the motor housing cover and position motor housing cover to the side. See figure S-41.
4. Remove the three (3) T-20 Torx motor retaining machine screws from each of the motor assemblies, disconnect the electrical connectors and remove the motors. Note the position and location of each motor before removal. See figure S-42.
5. Mark the location of the cover in relation to the tracks. This will assist in maintaining cable to motor timing during reassembly.
6. Remove the six (6) lower clamp arm retainers and lower clamp arms. See figure S-43.

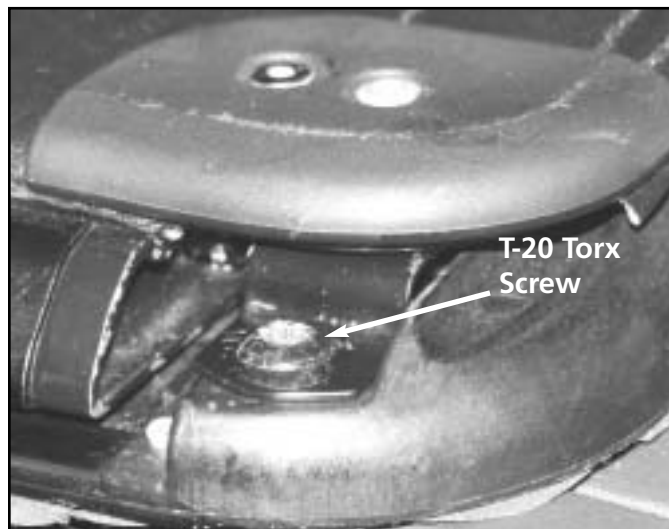

Figure S-39

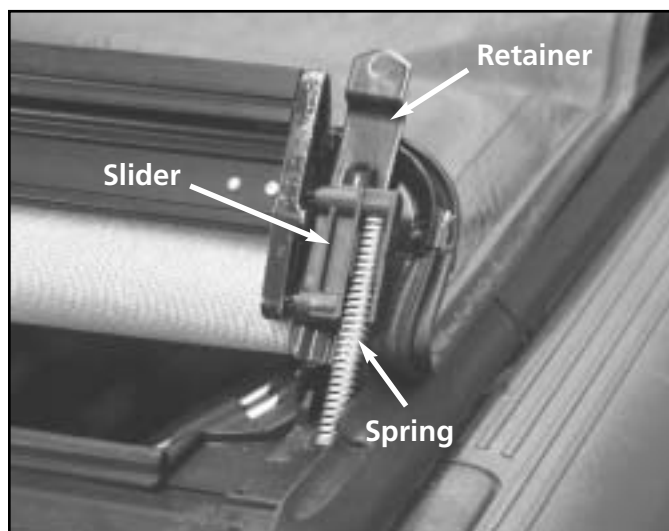

Figure S-40

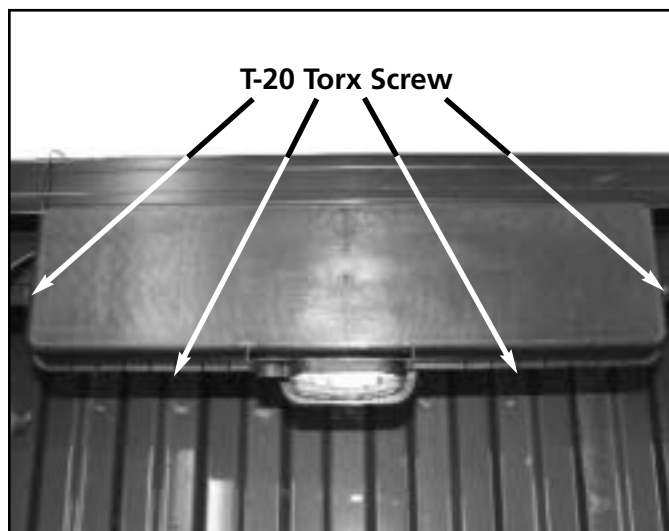

Figure S-41

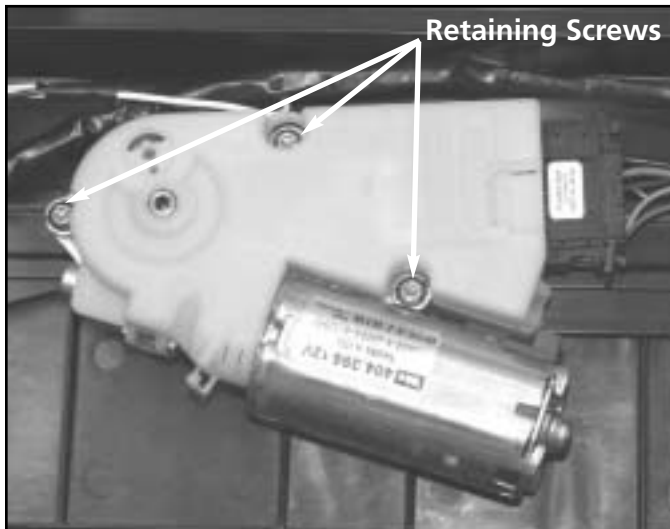

Figure S-42

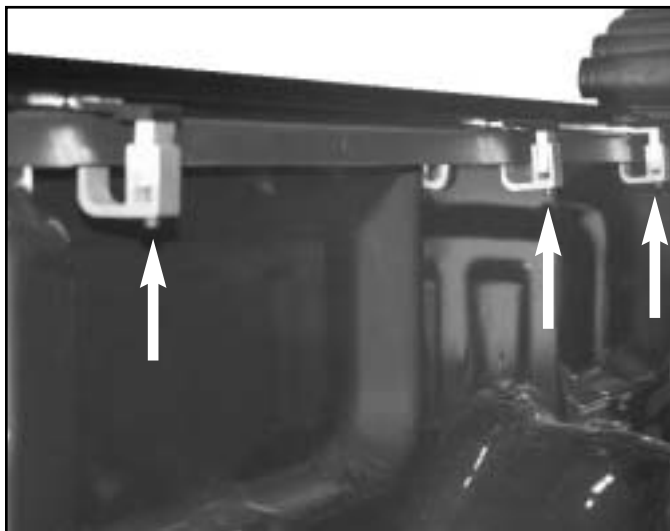

Figure S-43

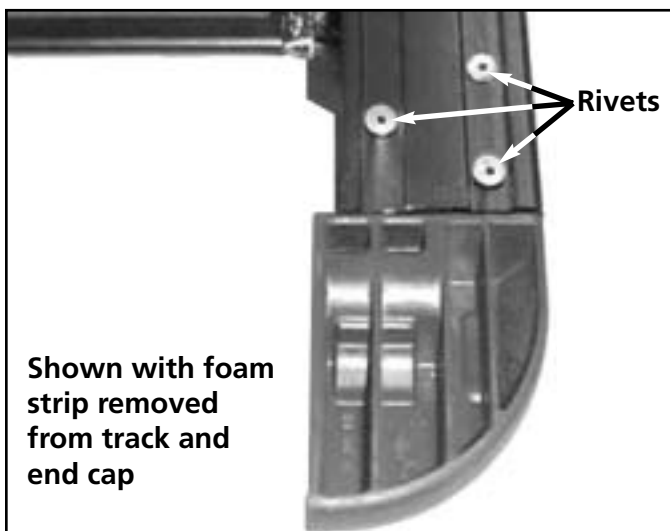

Figure S-44

7. Lift the tracks at the rear of the truck bed and remove 5 inches (12.7 cm) of foam tape from both tracks and end caps. The end cap retaining rivets should now be exposed.

8. Drill out the end cap retaining rivets on each track (3 per side) using care not to drill into the tracks themselves. Pull end caps out of track. See figures S-44 and S-45.

9. Pull the tonno cover rearward by pulling on the rear reinforcement until the trolleys are exposed at the end of the tracks. See figure S-46 on next page.

10. Pull the tracks away from the cover in order to disengage the rear reinforcement guide pins from the trolleys on both sides.

Note: The guide bushings are loose assemblies, be careful not to lose them.

See figure S-47 on next page.

11. Mark the position of the trolleys in the track and pull the trolley out of the track assembly. The trolley is attached to the cable and the cable will come out when pulling the trolley.

Note: Be sure to note which guide opening the cable came out of for later installation.

12. Install the new cables into the guide openings and attach the trolleys before installing the cables fully into the tracks.
13. Move the trolleys to the marked position and install the guide pins into the trolleys by pushing the tracks towards the cover.



Figure S-45

14. Insert the end caps into the tracks, install the rivets and fasten with a rivet gun. See figure S-48.
15. Cut a piece of foam tape 5 inches (12.7 cm) long to replace foam tape removed in step 7.

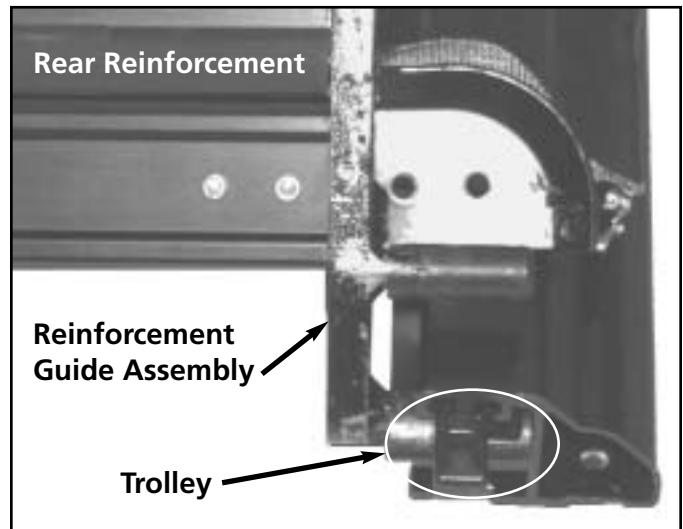

Figure S-46

16. Loosely install the lower clamp arms and fasteners to the upper clamp arms. Refer back to figure S-43.
17. Slide the cover assembly back to the first marked position on the tracks.

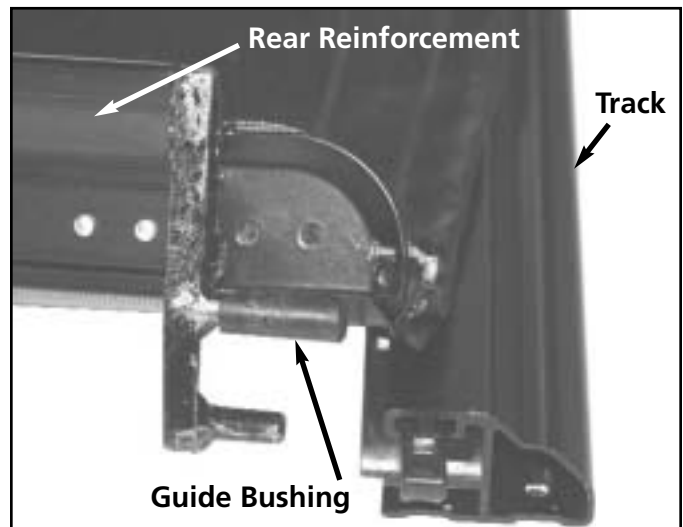

Figure S-47

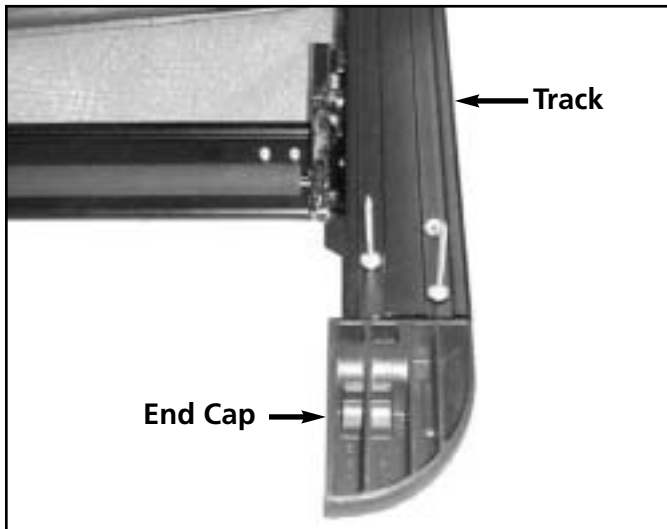

Figure S-48

18. Reinstall the motor assemblies in their original position, install the three (3) T-30 Torx retaining screws per motor and reconnect the electrical connectors. Refer back to figure S-42.
19. Install the motor cover and the four (4) T-20 Torx retaining screws and tighten. Refer back to figure S-41.
20. Fold the front cover reinforcement down over the motor cover and reinstall the sliders (2), slider retainers (2), and the slider springs onto the front reinforcement. Refer back to figure S-40.
21. Install the two (2) T-20 Torx screws into the slider retainer and front rail assembly and tighten. Refer back to figure S-39.
22. To ensure the motors are timed correctly to the cables, open the E-Z Power Tonno cover and disconnect the tonno fuse, this will erase the previous timing points.
23. Reinstall the fuse and operate the cover to within 3 to 4 inches of the full close position.
24. Re-initialize the E-Z Power Tonno Cover using the key fob and the following procedure: Close/Open, Close/Open, Close/Open.
25. The cover should move to the full closed position and then open automatically and then again close automatically. If the cover does not move as described above, repeat step 24.

3.10 Cover with Light Assembly Replacement

1. Open the tonno cover fully to access truck bed.
2. Remove the two (2) slider retainer T-20 Torx screws from the front rail. See figure S-49.
3. Remove the slider retainers and pull the cover back and up in order to expose the motor cover. See figure S-50.

⚠WARNING

Slider spring is under slight tension. Exercise care while releasing spring. Wear safety glasses during this procedure to avoid possible eye injury.

4. Remove the four (4) T-20 Torx motor cover retaining screws. See figure S-51.
5. Remove the motor cover and position it upside down in order to expose the RKE module. See figure S-52.
6. Peel the RKE module away from the adhesive tape.
7. Remove the RKE module and note the routing of the antenna.
8. Disconnect the 2 pin connector for the light. See figure S-53.
9. Remove the RKE reset button from the motor cover by loosening the 8mm retainer nut. See figure S-53.

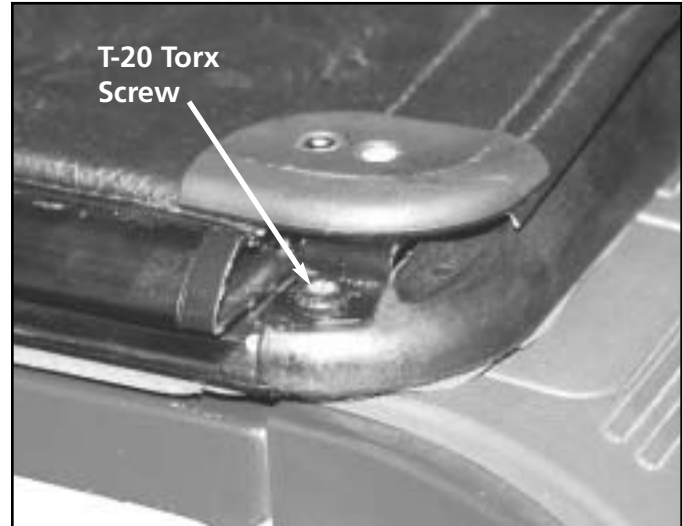

Figure S-49

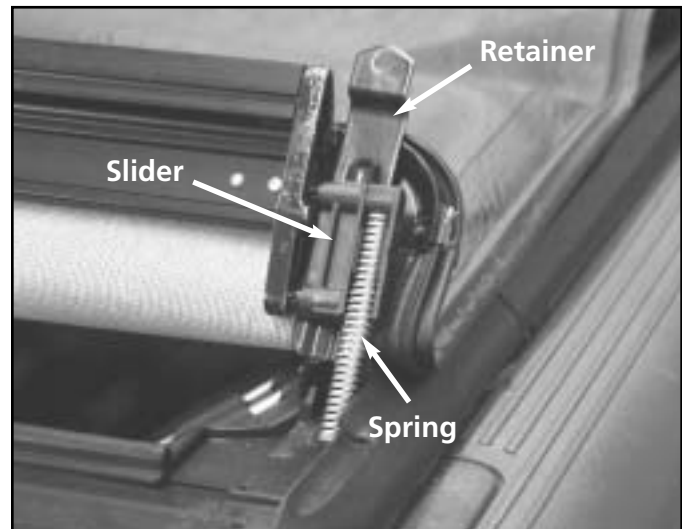

Figure S-50

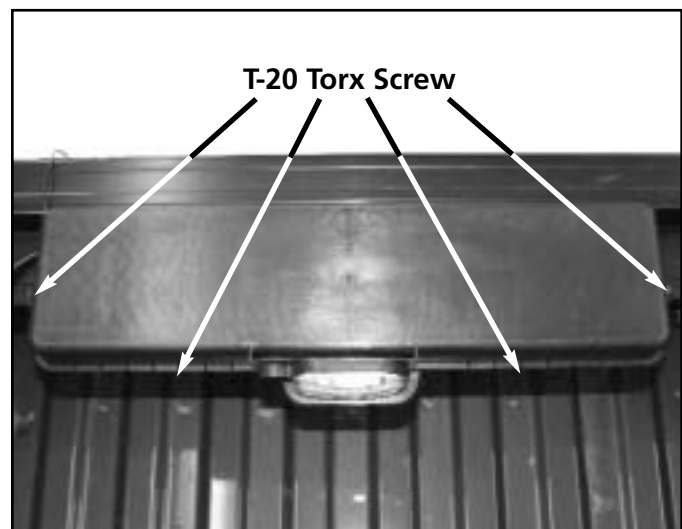

Figure S-51

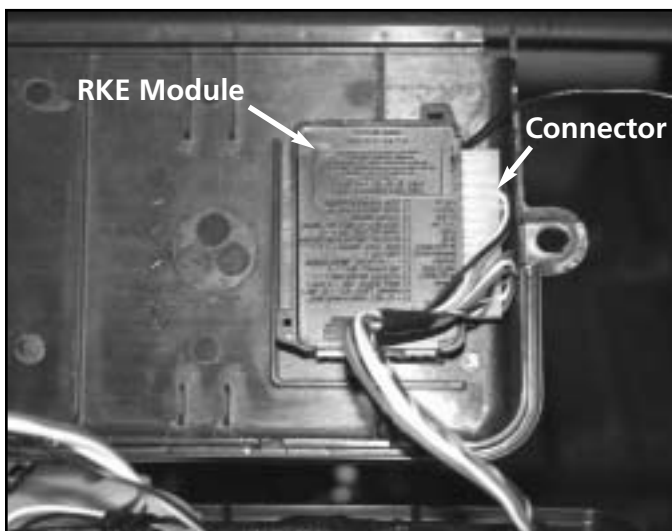

Figure S-52

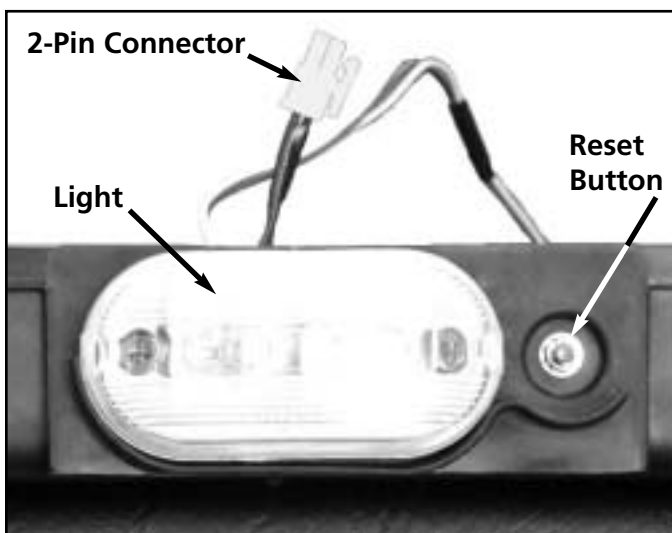

Figure S-53

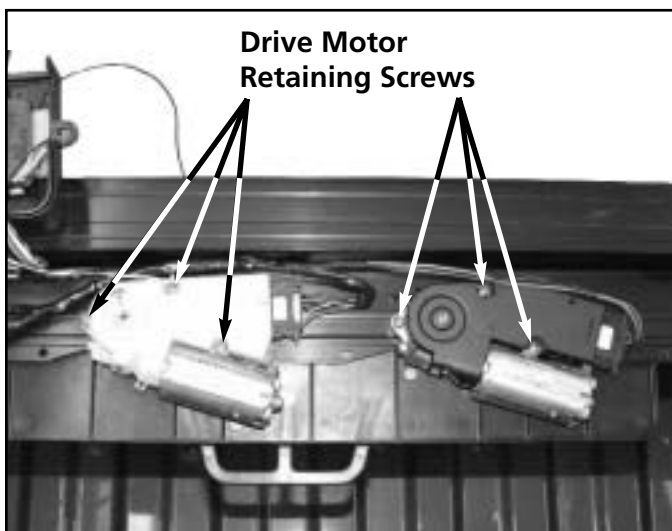

Figure S-54

10. Remove the six (6) drive assembly retaining screws (Three screws per drive assembly). See figure S-54.
11. Remove the lower cover from the front rail.
12. Position the new bottom cover under the rail and insert the six (6) drive assembly retainer screws and tighten. Refer back to figure S-54.
13. Install the RKE reset switch into the motor cover and fasten with the 8mm nut. Refer back to figure S-53.
14. Connect the 2 pin wire connector for the light. Refer back to figure S-53.
15. Attach the RKE module to the adhesive tape and properly route the antenna. Refer back to figure S-52.
16. Position the motor cover over the rail and insert the four (4) motor cover retainer screws. Refer back to figure S-51.
17. Tighten the motor cover retainer screws.
18. Move the tonno cover over the motor cover and front rail. Be sure the slider, slider spring and slider retainer are installed. Refer back to figure S-50.
19. Install the two (2) T-20 Torx screws through the slider retainers onto the front rail and fasten. Refer back to figure S-49.

3.11 Reinforcement Assembly - Rear

1. Open the tonno cover fully.
2. Remove the six (6) clamp arm fastener screws and lower clamp arm jaws. See figure S-55.
3. Slide the tonno assembly rearward on the truck bed approximately one to two feet.
4. Cut and clear 5 inches (12.7 cm) of the foam tape from the end caps and tracks.
5. Drill out the three (3) rivets on each end cap and track.
6. Remove the end caps from the tracks. See figure S-56.
7. Close the tonno cover. See figure S-57.

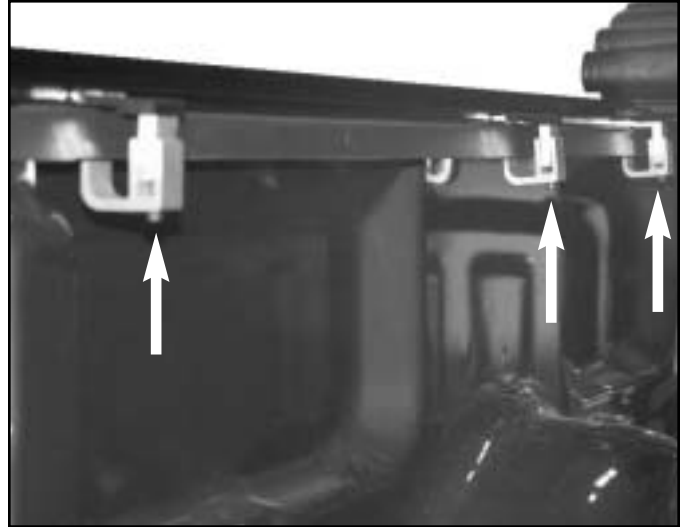

Figure S-55

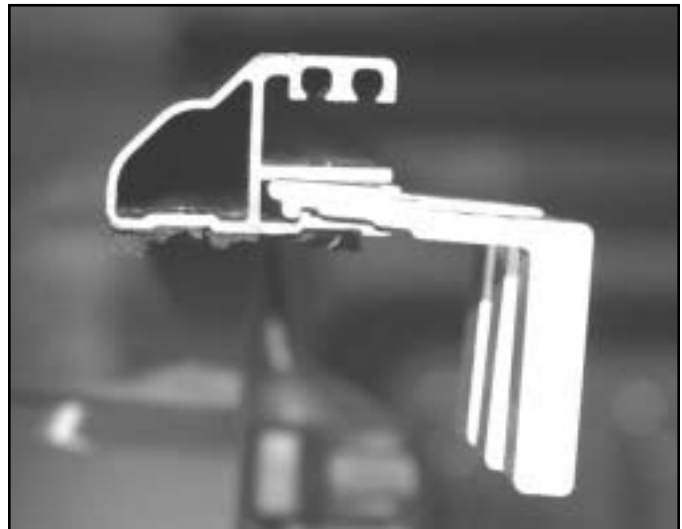

Figure S-56

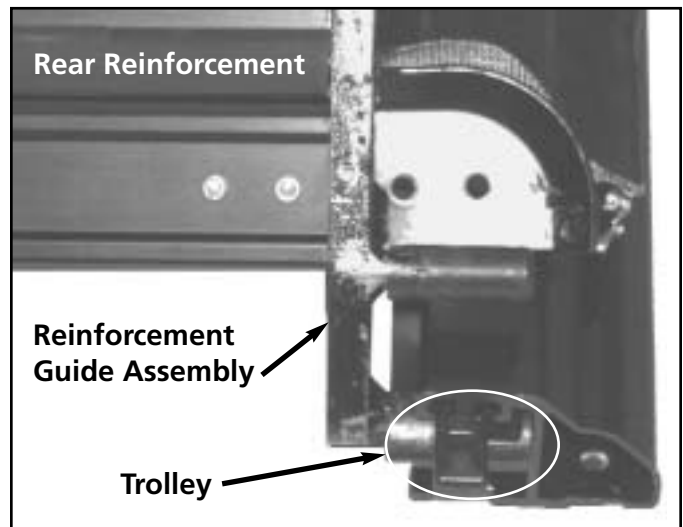

Figure S-57

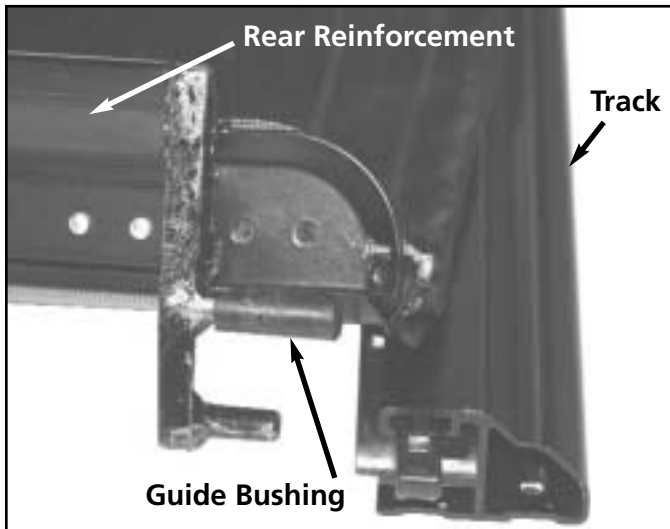

Figure S-58

8. Release the rear cover reinforcement from the trolleys. See figure S-58.



Figure S-59

9. Drill out the decorative cap rivets and remove. See figure S-59.

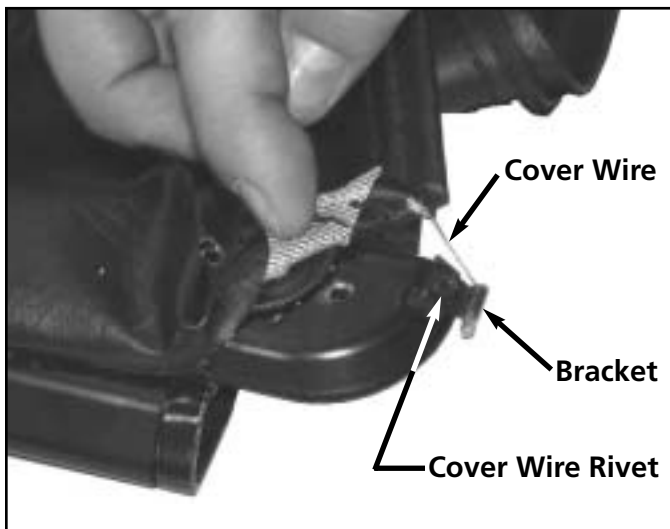

Figure S-60

10. Lift the side of the tonno cover at the rear reinforcement to expose the cover wire rivet. See figure S-60.

11. Drill out the cover wire rivet on both sides of the reinforcement. See figure S-61.

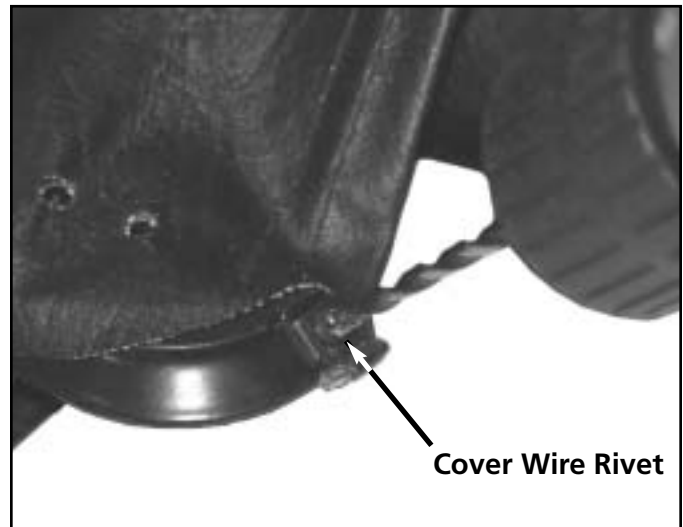

Figure S-61

12. Lift the reinforcement and slide it off of the cover by moving it sideways. See figure S-62.

13. Slide the new reinforcement onto the cover.

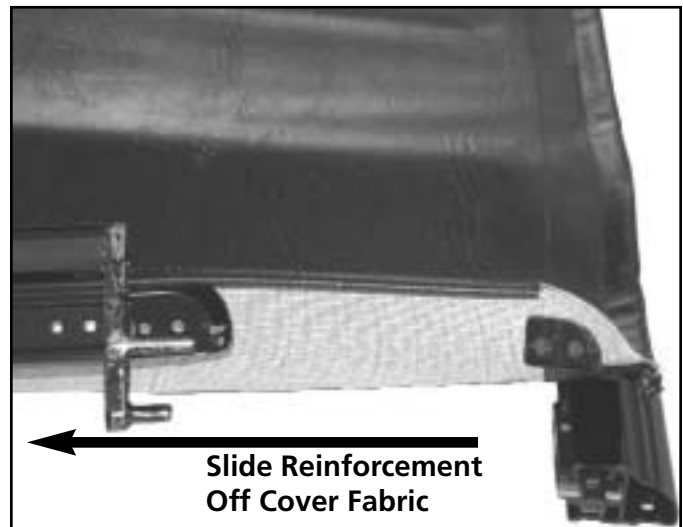

Figure S-62

14. Insert the small rivet through the cover wire bracket into the corner support. Repeat the step for both sides.

15. Fasten the rivet with a rivet gun. See figure S-63.

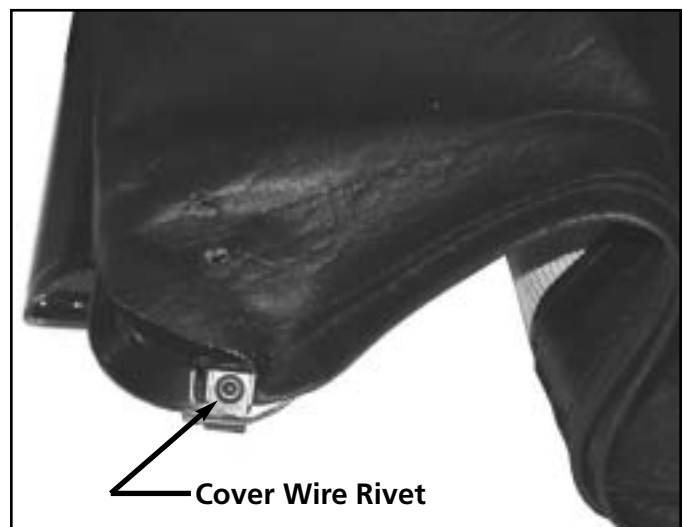

Figure S-63



Figure S-64

16. Install two (2) rivets per side through the decorative cap and cover into the reinforcement corner support assembly. Repeat the step for both sides. See figure S-64.

17. Fasten the rivets with a rivet gun.

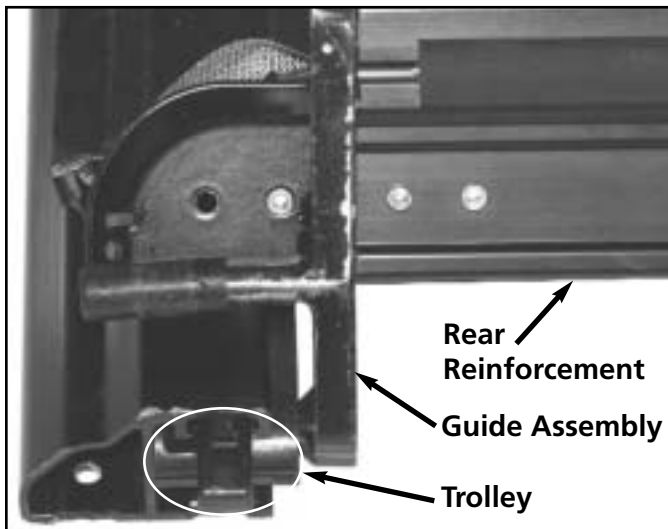

Figure S-65

18. Insert the rear cover reinforcement into the trolleys. See figure S-65.

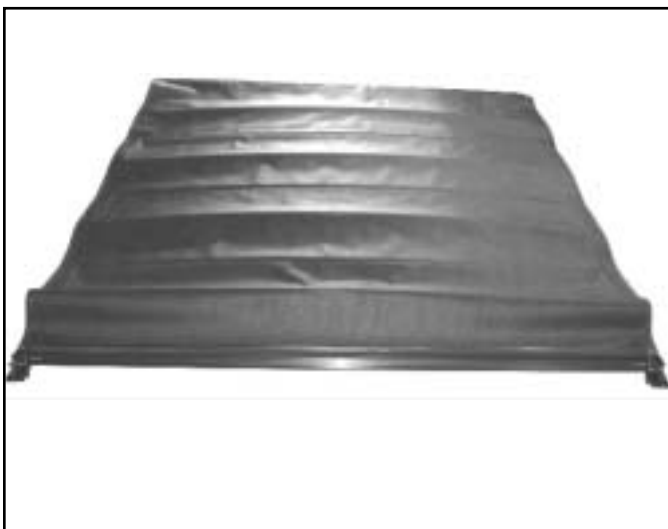

Figure S-66

19. Turn the reinforcement down in order for the guide bushings to run into the track and open the tonno cover. See figure S-66.

20. Insert the end caps into the track assemblies.
See figure S-67.

21. Insert the three (3) rivets per side through the tracks into the end caps.

22. Fasten the rivets with a rivet gun.

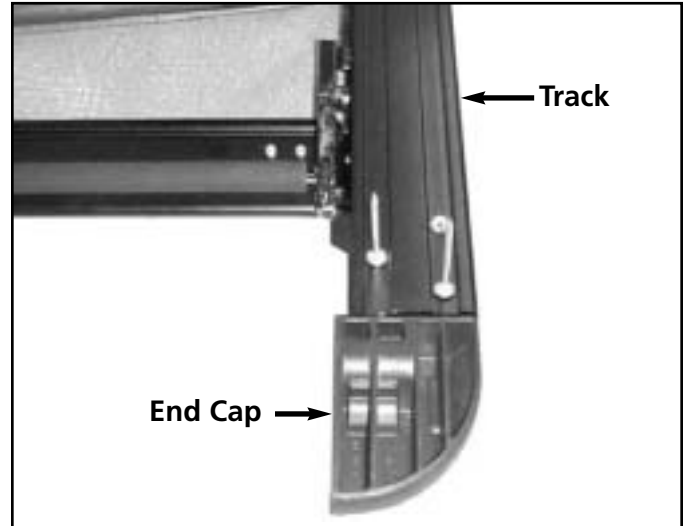

Figure S-67

23. Cut a piece of foam tape 5 inches (12.7 cm) long to replace foam tape removed in step 4.

24. Slide the tonno assembly back into the original position on the truck bed.

25. Install the six (6) lower clamp jaws and clamp arm fastener screws. Refer back to figure S-55.

26. Tighten the six (6) clamp arm fastener screws. Refer back to figure S-55.

27. Close the tonno to verify correct operation, alignment and aesthetics.

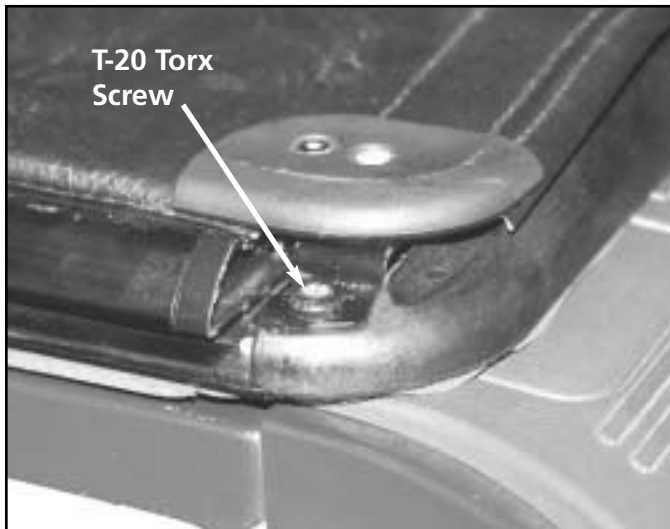

Figure S-68

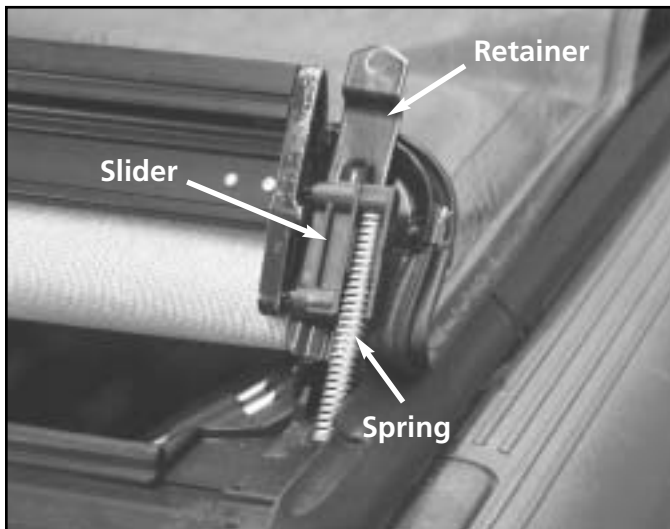

Figure S-69

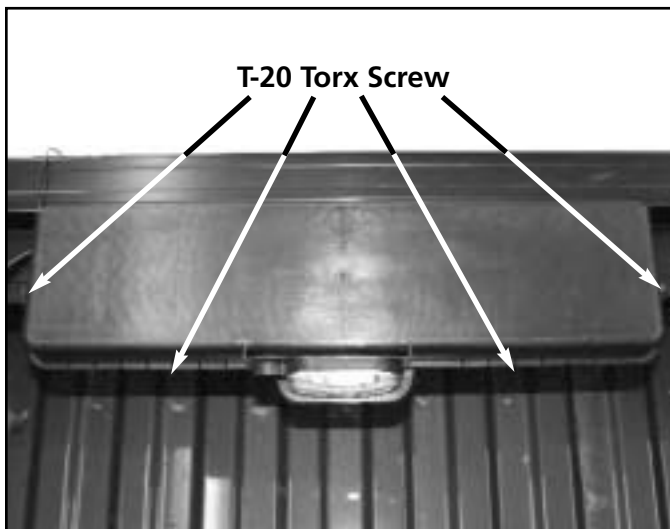

Figure S-70

3.12 Front Rail Assembly Replacement

1. Remove tonno cover assembly from truck bed as described in section 3.1, steps 1 through 4.

2. Remove the two (2) T-20 Torx screws from the slider retainers and pull the cover back and away from the rail assembly. See figures S-68 and S-69.

⚠ WARNING
 Slider spring is under slight tension. Exercise care while releasing spring. Wear safety glasses during this procedure to avoid possible eye injury.

3. Remove the four (4) T-20 Torx motor cover retainer screws and the motor cover. See figure S-70.

4. Remove the three (3) motor retaining screws from each motor and remove the motors with the wire harness connected. Note the position and location of each motor. See figure S-71.

5. Remove the lower motor cover from the rail assembly.

6. With the help of an assistant, turn the tonno cover topside down so that the bottom of the tracks and rail are visible.

7. Cut away the foam tape from the front rail to expose the track retainer rivets on both tracks. See figure S-72.

8. Drill out the three (3) retainer rivets on both of the track assemblies. See figure S-73.

9. Disengage the forward most bow from the lifters on the front rail.

10. With the help of an assistant one person should hold the rear cover reinforcement while another pulls the front rail from the tracks.

Note: Reference mark which guide openings the cables are in for later installation of the new front rail.

See figures S-74 and S-75.

11. Position replacement front rail assembly in front of tracks ready for installation.

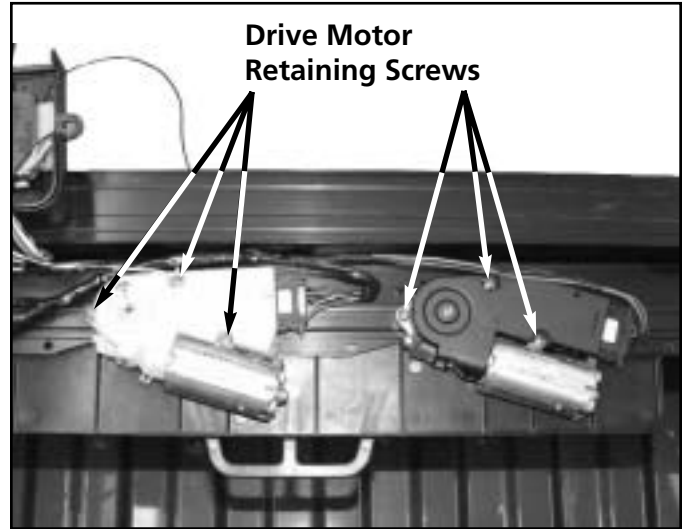

Figure S-71

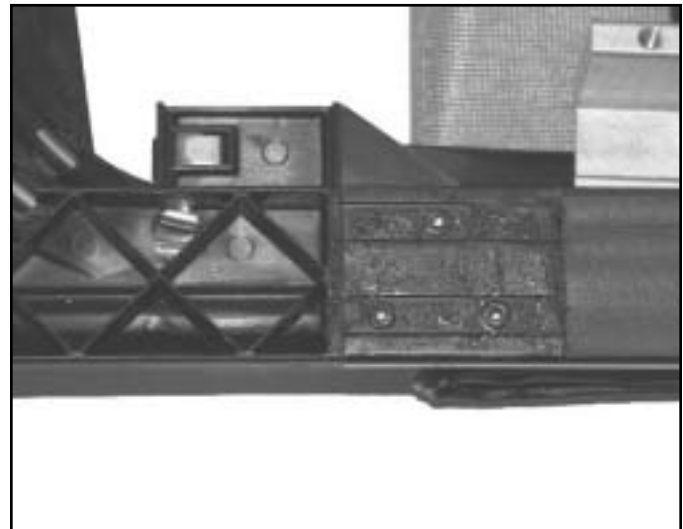

Figure S-72

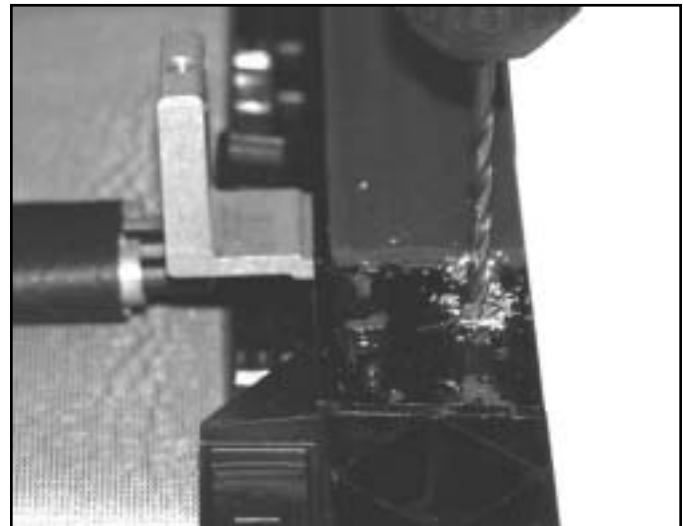

Figure S-73

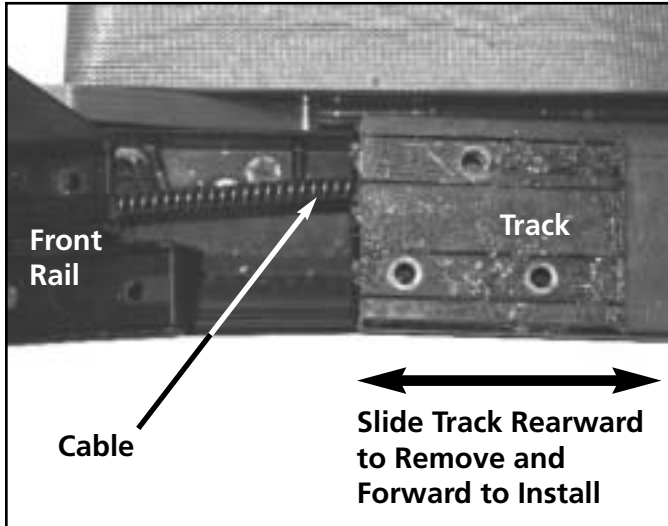

Figure S-74

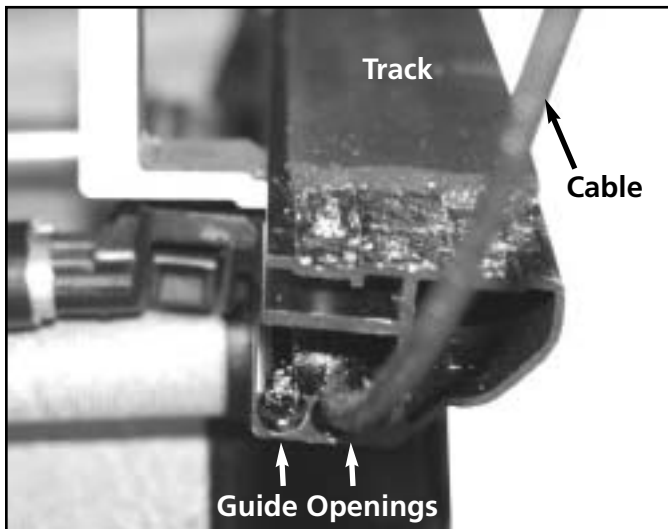

Figure S-75



Figure S-76

12. Insert the cables into the guide openings that the cables came out of and push the replacement rail assembly onto the tracks. See figures S-74 and S-75.
13. Install the three (3) retainer rivets on both tracks. See figure S-76.
14. Fasten the rivets from the tracks to the rail using a rivet gun.
15. Measure and cut replacement foam tape to cover the exposed area of the front rail and tracks that was removed in step 7.
16. With the help of an assistant turn the cover over so that the cover side is facing up.
17. Install the motor assemblies and route the wiring.
18. Install the lower motor cover and fasten it with the retainer screws for the motor assemblies. Refer back to figure S-71.
19. Tighten the motor retainer screws.
20. Install the motor cover, the four (4) T-20 Torx motor cover retaining screws and tighten. Refer back to figure S-70.
21. Fold the cover down over the motor cover and install the slider, slider spring and slider retainer on both sides. Refer back to figure S-69.
22. Install the two (2) T-20 Torx into the slider retainer to the front rail and tighten. Refer back to figure S-68.
23. Install tonno cover assembly on truck bed as described in section 3.1, steps 5 through 9.

3.13 Cover Fabric Replacement

1. Open the tonno 3 to 4 inches (8 to 10 cm) from the full closed position.
2. Drill out the two (2) rivets on each of the decorative caps. See figure S-77.



Figure S-77

3. Lift the side of the cover to expose the cover wire rivet on each corner.
4. Drill out the cover wire rivets on each corner. See figure S-78.

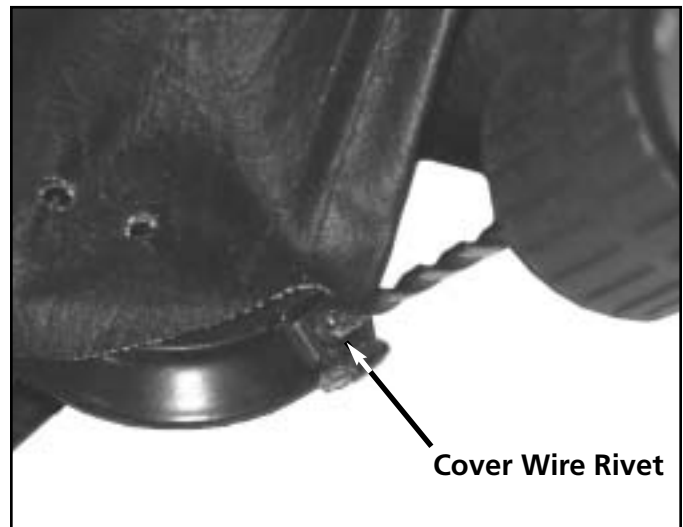

Figure S-78

5. Remove the six (6) clamp arm fasteners and lower clamp arm jaws. See figure S-79.
6. Disconnect the 2 pin main wire harness connector.
7. With help of an assistant, remove the tonno cover from the truck bed and move it to a clean work surface and set it down bottom side up.

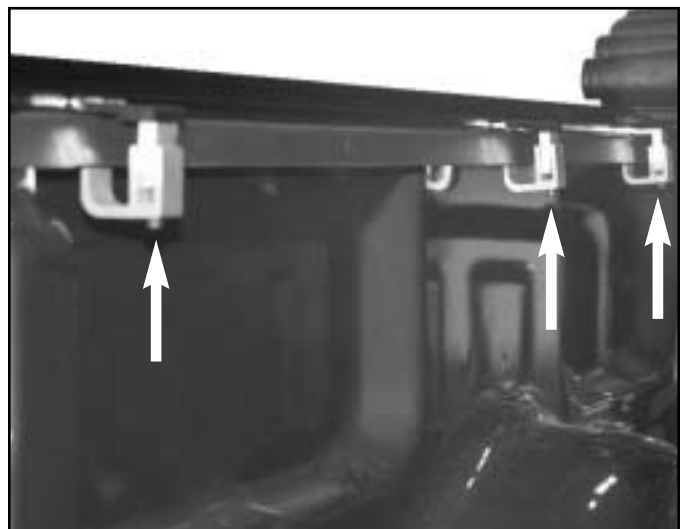

Figure S-79

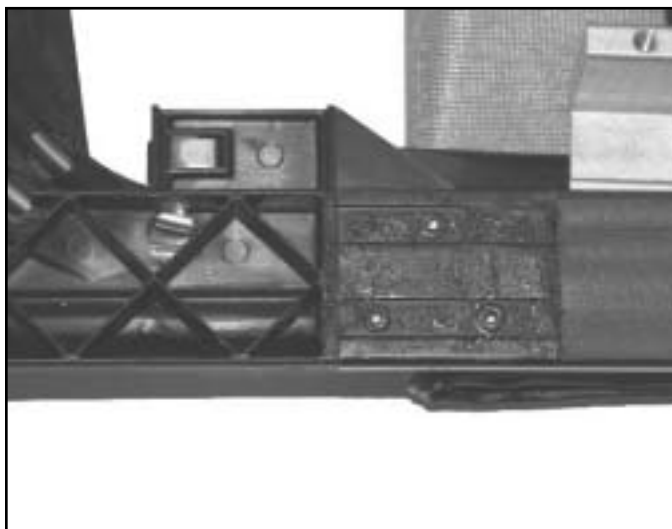

Figure S-80

8. Peel back the foam tape 11 inches (28 cm) from the front rail to the track to expose the three (3) retaining rivets. See figure S-80.

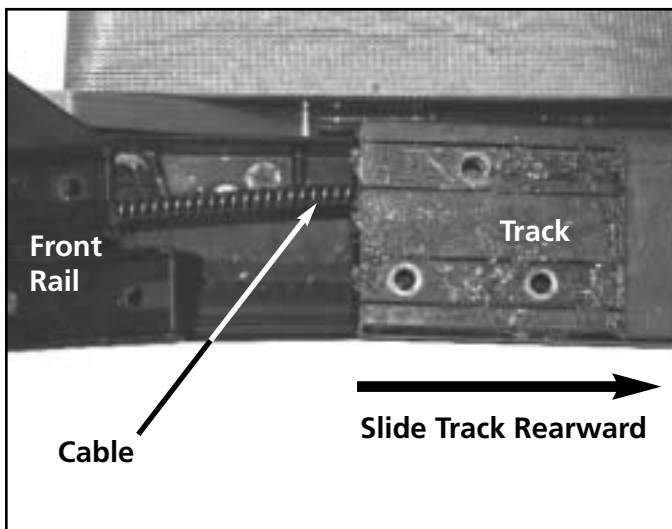

Figure S-81

9. Drill out the rivets on one of the tracks and slide the track away from the rail assembly disengaging it from the lifters. See figure S-81.

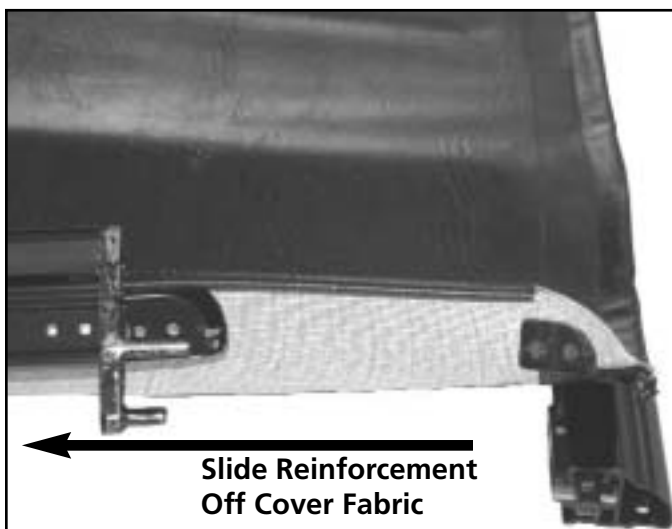

Figure S-82

10. Slide front and rear reinforcements off of the cover fabric. See figure S-82.
11. Slide the lifters off of the bows and then the bows off of the other lifters.
12. Slide the reinforcement bows out of the cover fabric loops and discard the cover fabric.
13. Insert the reinforcement bows into the replacement cover fabric loops.
14. Insert the bows onto the lifters then the opposite side lifters into the bows.

15. Slide the track over the lifters and insert it into the rail. See figure S-83.

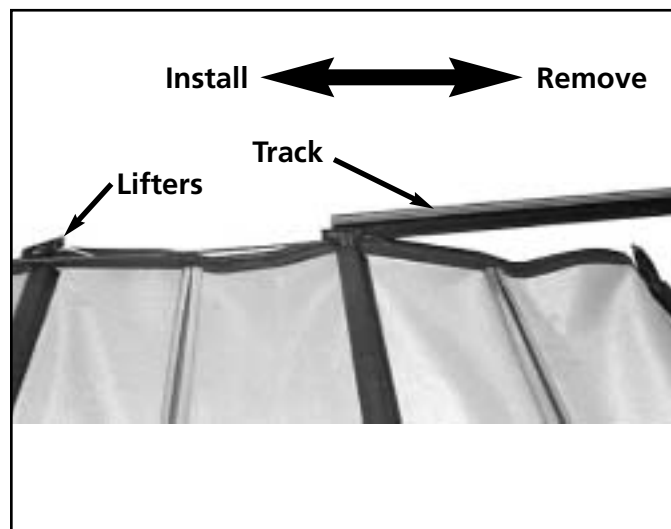

Figure S-83

16. Insert the three (3) rivets through the track into the rail. See figure S-84.
17. Fasten the rivets with a rivet gun.



Figure S-84

18. Measure and cut replacement foam for the exposed area. See figure S-85.

19. With the help of an assistant, turn the tonno cover over and reinstall the tonno onto the truck bed.

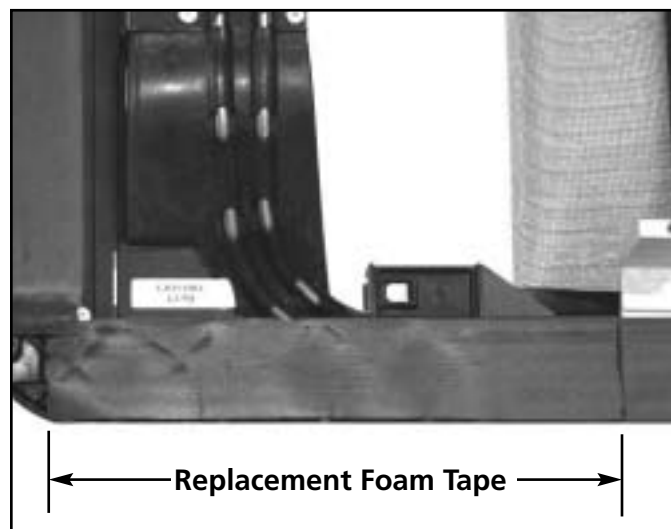

Figure S-85

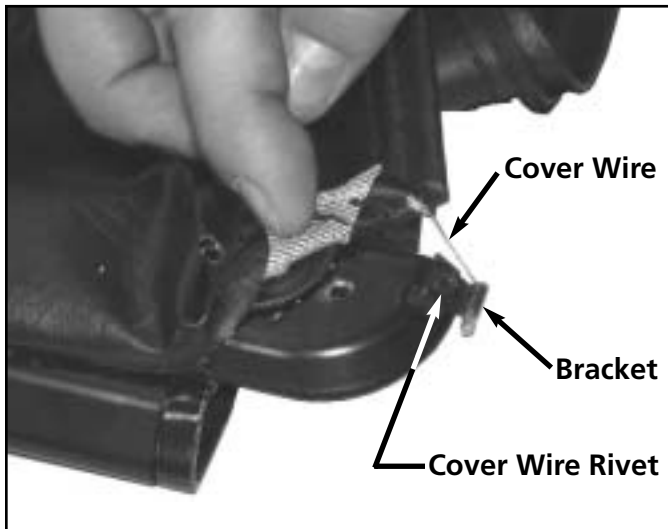

Figure S-86

- 20. Hold the cover wire bracket in place on the corner support assemblies. See figure S-86.
- 21. Insert the small rivet through the cover wire bracket into the corner support assembly and fasten with a rivet gun. See figure S-86.



Figure S-87

- 22. Set the four (4) decorative corner caps into place on the cover.
- 23. Insert the rivets through the decorative caps into the cover reinforcements.
- 24. Fasten the rivets with a rivet gun.

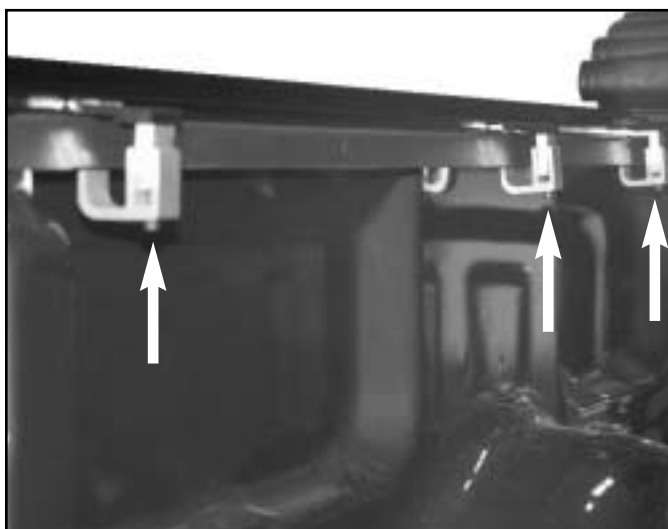

Figure S-88

- 25. Install the six (6) lower clamp jaws and clamp arm fastener screws. See figure S-88.
- 26. Connect the 2 pin main wire harness connector.
- 27. Operate the tonno cover and check for correct operation and alignment.
- 28. Tighten the clamp arm fastener screws.

3.14 Light Assembly Replacement

1. Open the tonno cover to the full open position.
2. Firmly grasp the lens cover and pull away from the light base. See figure S-89.
3. Remove the two (2) T-20 Torx screws from the light base. See figure S-90.
4. Pull the light base away from the rail in order to access the wire connector. See figure S-91.
5. Disconnect the 2 pin light wire harness connector. See figure S-91.
6. Connect the new light wire harness connector.
7. Position the light base onto the front rail.
8. Install and fasten the two (2) T-20 Torx screws.
9. Install the new lens by pushing it onto the light base.
10. Check the operation of the light by activating the light on the key fob.

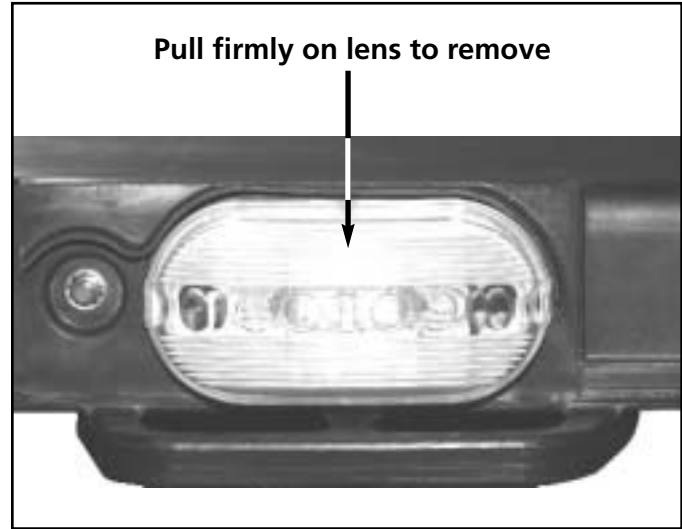

Figure S-89



Figure S-90



Figure S-91

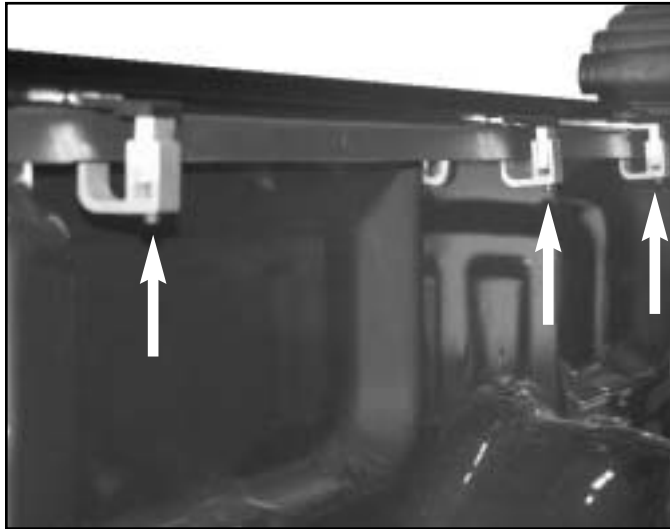

Figure S-92

3.15 Clamp Set Replacement

1. Open the tonno cover more than half.
2. Disconnect the 2 pin main wire harness connector.
3. Remove the six (6) clamp arm screws. See figure S-92.

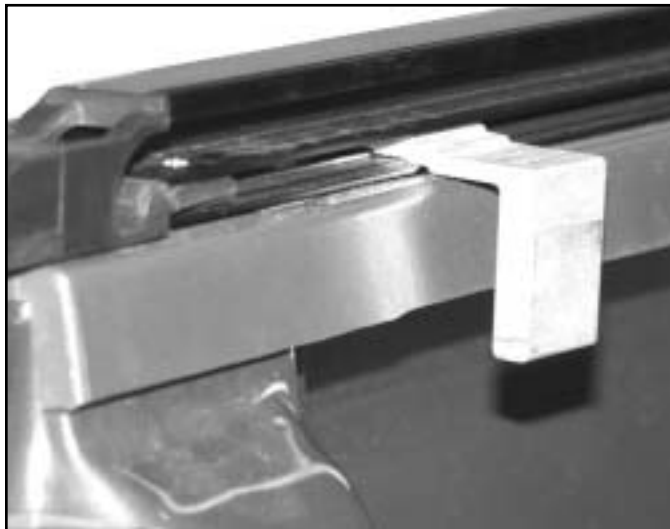

Figure S-93

4. Remove the six (6) lower clamp jaws. See figure S-93.



Figure S-94

5. Slide the complete tonno assembly rearward on the truck bed approximately 2 feet (61 cm). See figure S-94.

6. Cut and remove five inches (12.7 cm) of foam from the end cap and track in order to expose the rivets.

7. From the under side of the tracks, drill out the three (3) rivets per side being careful not to drill into the tracks. See figure S-95.
8. Remove the end caps by pulling them rearward.
9. Slide the upper clamp arms rearward until free from track. See figure S-96.
10. Insert the new upper clamp arms into the tracks in the same order they were removed.
11. Insert the end caps into the tracks.
12. Insert the three (3) rivets per side to fasten the end caps to the tracks. Refer back to figure S-95.
13. Fasten the rivets with a rivet gun.
14. Cut a piece of foam tape 5 inches (12.7 cm) long to replace foam tape removed in step 6.
15. Position the upper clamp arms in the position as they were before being removed. Refer back to figure S-93.
16. Install tonno cover assembly on truck bed as described in section 3.1, steps 5 through 9.

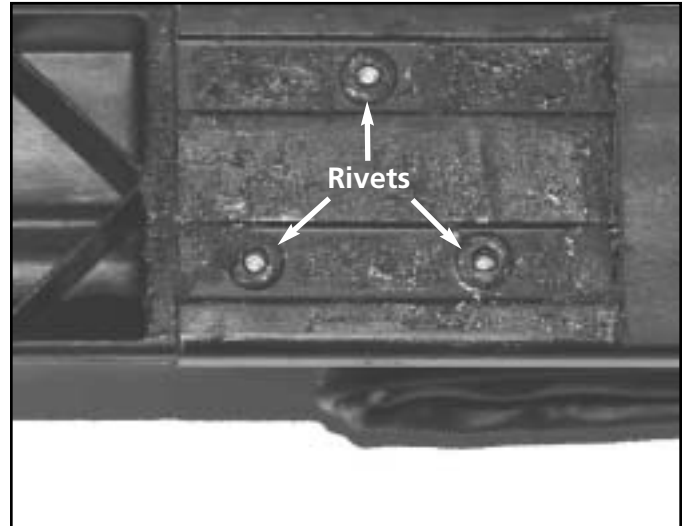

Figure S-95

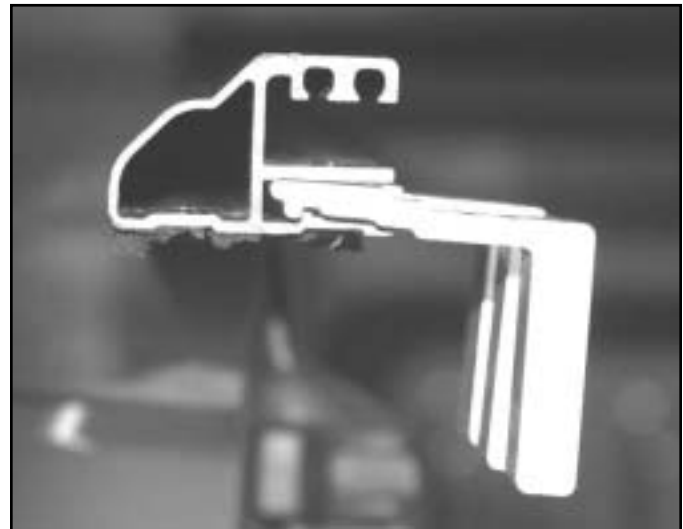
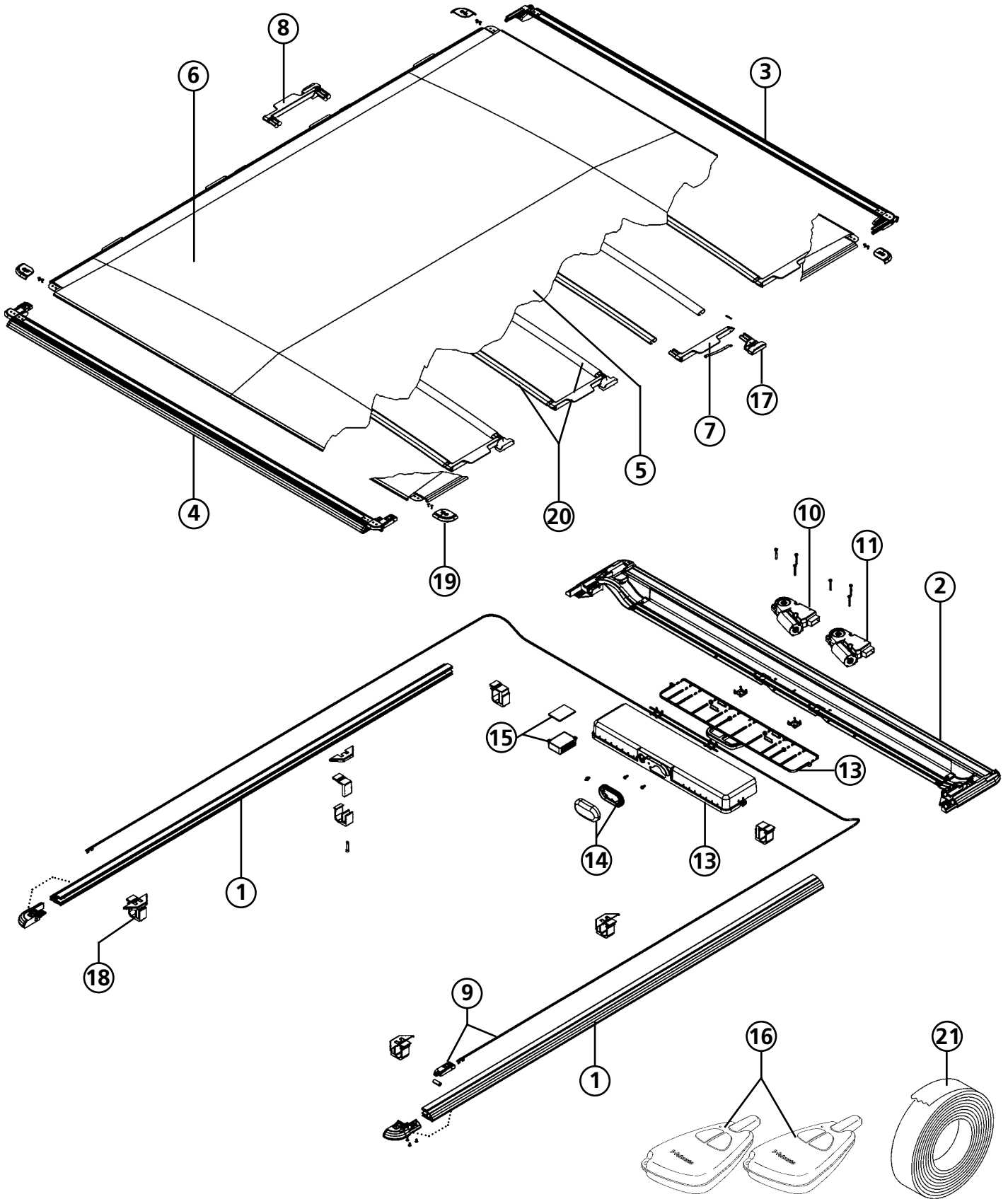

Figure S-96

Notes

4.1 Service Parts



Item	Parts Included	Part Number	Description	Shipped
1	1	S8504-TN-7100A-A	Track Assembly RH &LH	
	1		Track - RH	
	1		Track - LH	
	1		Cap - Rear - RH	Loose Part
	1		Cap - Rear - LH	Loose Part
	6		Rivets	In Bag
	1		Foam Tape	Loose Roll
2	1	S8504-TN-7200A-A	Front Rail Asm	
	2		Front Rail	
	1		Wear Plate	Loose Parts in Bag
	1		Corner Drive Asm RH	Assembled to Rail
	1		Corner Drive Asm LH	Assembled to Rail
	1		Lifter Arm Front RH	Assembled to Rail
	1		Lifter Arm Front LH	Assembled to Rail
	2		Pin - Lifter Arm	Assembled
	2		Spring Lifter Arm	Assembled
	1		Slider - RH	Loose Part
	1		Slider - LH	Loose Part
	2		Spring - Slider	Loose Part
	2		Retainer - Slider	Loose Part
	2		Screw - Machine	Loose Part
	8		Rivets	Assembled
	6		Rivets	In Bag
1	Bag	For Rivets		
3	1	S8504-TN-5100A-A	Reinforcement Asm. - Cover Front	
	1		Reinforcement	Assembled
	1		Corner Support Asm - Front RH	Assembled
	1		Corner Support Asm - Front LH	Assembled
	1		Bracket - Wire Connector - RH	Assembled
	1		Bracket - Wire Connector - LH	Assembled
	3		Flock Tape	Assembled
	4		Rivet	Assembled
	1		Cap Decorative RH	Loose part
	1		Cap Decorative LH	Loose Part
4	Rivet	For Decorative Caps		
2	Rivet	For Wire Asm.		
4	1	S8504-TN-5101A-A	Reinforcement Asm Cover Rear	
	1		Reinforcement	
	1		Corner Support - Rear - RH	Assembled
	1		Corner Support Asm - Rear - LH	Assembled
	1		Bracket - Wire Connector - RH	Assembled
	1		Bracket - Wire Connector - LH	Assembled
	2		Badge	Assembled
	1		Seal	Assembled
	1		Cap Decorative RH	Loose part
	1		Cap Decorative LH	Loose Part
	4		Rivet	For Decorative Caps
	2		Rivet	For Wire Asm.
2	Bushing	Loose Part		

Item	Parts Included	Part Number	Description	Shipped
5	1 1 2 7 1 1 1 1 2 2 8 3 2 2 8 4 1	S8504-TN-5000A-A	Cover Assembly Complete Fabric Asm Reinforcement Reinforcement - Primary Bows Corner Support Asm - Front RH Corner Support Asm - Front LH Corner Support - Rear - RH Corner Support Asm - Rear - LH Bracket - Wire Connector - RH Bracket - Wire Connector - LH Rivet Flock Tape Cap Decorative RH Cap Decorative LH Rivet Rivet Seal	Sewn cover Asm Assembled 3 asm.- 4 loose Assembled Assembled Assembled Assembled Assembled Assembled Assembled Assembled Assembled Assembled Assembled Assembled Assembled
6	1 2 2 2 8 4	S8504-TN-5200A-A	Cover Assembly Fabric Asm Wire Asm Fabric Cap Decorative RH Cap Decorative LH Rivet Rivet	Asm. To Fabric Loose Part Loose Part For Decorative Caps For Wire Asm.
7	1 1 1 1 1 1	S8504-TN-5404A-B	Lifter Arm Asm - RH Guide - Sliding Lifter Arm - RH Pin - Lifter Arm Spring Lifter Arm Bag Label	Assembled Assembled Assembled Assembled Heavy duty
8	1 1 1 1	S8504-TN-5405A-B	Lifter Arm Asm - LH Guide - Sliding Lifter Arm - LH Pin - Lifter Arm Spring - Lifter Arm	Assembled Assembled Assembled Assembled
9	1 1 2	S8504-TN-3100A-A	Trolley and Cable Asm - RH & LH Trolley - RH Trolley - LH Cable Asm	Loose Part Loose Part Loose Part
10		S8504-TN-2000A-A	Drive Asm - MDII Primary Drive Asm - MDII	White
11	1	S8504-TN-2000B-A	Drive Asm - MDII Secondary Drive Asm - MDII	Black

Item	Parts Included	Part Number	Description	Shipped
-	1 1 1 1 1 1	S8504-TN-2300A-A	Wire Harness Assembly Wire Harness Asm- Vehicle Wire Harness Asm- Module Wire Harness-Battery Wire Harness-Ground Splice	Loose part Loose part Loose part Loose part Loose part
13	1 1 1 1 2	S8504-TN-2400A-B	Cover Light Assembly Cover/ Motor Base Asm Cover Asm Motor - Outer Fasteners for Base Housing and Connector Asm Lens Screw Machine	Assembled to Cvr. Assembled to Cover Asm. to Light Asm.
14	1 1 2	S8504-TN-2110A-A	Light Asm Lens Housing and Connector Asm Screw Machine	Assembled Assembled Assembled
15	1 2 1	S8504-TN-2120A-A	RKE Receiver Set RKE Receiver Key FOB Tape/Acrylic	
16	1 1	S8504-TN-2021A-A	FOB - Extra Key FOB Activation Instructions	
17	1 1 2 2 2	S8504-TN-8008A-B	Slider Assembly Slider - RH Slider - LH Spring - Slider Retainer - Slider Screw - Machine	Loose Part Loose Part Loose Part Loose Part Loose Part
18	1 1 1 1	S8504-TN-8004A-A	Clamp Set Clamp - Jaw Clamp - Cover Clamp Arm Screws	Loose Part Loose Part Loose Part Loose Part
19	1 2 2 8	S8504-TN-5312A-A	Decorative Cap Cap Decorative RH Cap Decorative LH Rivet	Loose Part Loose Part Loose Part
20	1	S8504-TN-5004B-B	Primary Bow	Bulk
21	1	S0000-A-9053-A-A	Weatherproof Foam Tape	Long Roll
-	1	8W04-TN-8020A-A	Installation Manual	
-	1	8W04-TN-8030A-A	Owners Operating Instructions	

Notes



Org. 07/2002 907407

Webasto Product North America, Inc.

Sunroof / Tonno Division

7963 Lochlin Drive
Brighton, MI 48115
Phone (248) 486-7100
Toll-free (800) 860-7866
Fax (248) 486-7111

Technical Assistance
USA: (800) 337-6731

Thermosystems Division

3333 John Conley Drive
Lapeer, MI 48446
Phone (810) 245-2400
Toll-free (800) HEATER-1
Fax (810) 664-7720

Technical Assistance Hotline
USA: (800) 555-4518
Canada: (800) 667-8900

www.webasto-us.com